

20 30 40 50

**DISTO™** *pro<sup>4</sup> / pro<sup>4</sup> a*



***User Manual***  
***Version 1.0, English***

***Leica***  
**Geosystems**



## ***DISTO™ pro<sup>4</sup> / pro<sup>4</sup> a hand-held laser meter***

**Congratulations on your purchase of a DISTO!**



en

Leica Geosystems products are of top quality, are top performers and provide the highest degree of productivity.

  This User Manual contains important safety instructions (see section "Safety Instructions") as well as instructions on use of the instrument. Read carefully through the User Manual before you switch on the instrument.

## ***Product identification***

Enter model designation and serial number in your User Manual, and always refer to this information when you need to contact your **agency or service centre.**

## ***Symbols used***

The symbols used in this User Manual have the following meanings:

 **DANGER:** Indicates an imminently hazardous situation which, if not avoided, will result in death and serious injury.

 **WARNING:** Indicates a potentially hazardous situation or an unintended use which, if not avoided, could result in death or serious injury.

 **CAUTION:** Indicates a potentially hazardous situation or an unintended use which, if not avoided, may result in minor injury and/or in appreciable material, financial and environmental damage.

 Important paragraphs which must be adhered to in practice as they enable the product to be used in a technically correct and efficient manner.

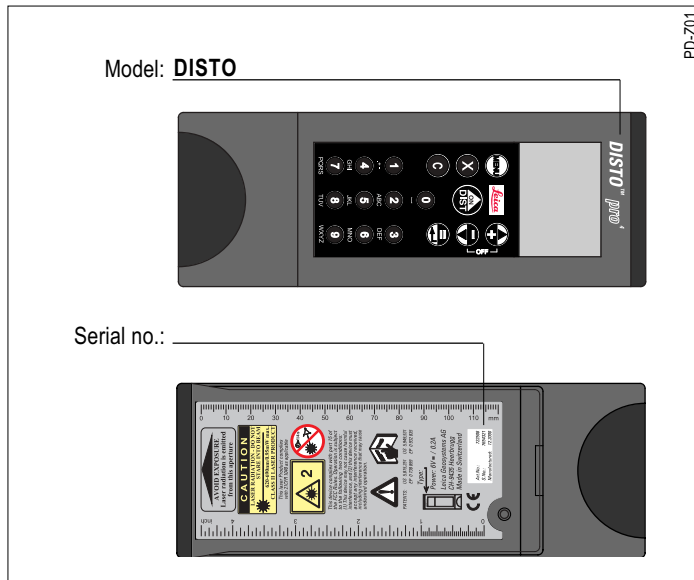

Product identification .....	4	Measuring from flat planes .....	17
Symbols used .....	4	Measuring from corners .....	18
<b>Introduction .....</b>	<b>7</b>	Measuring from edge .....	18
Special features .....	7	Measuring with stand .....	18
Area of applicability .....	7	Measuring with alignment aid .....	18
Modes of operation .....	7	Measuring with accessories .....	19
Normal mode .....	7	<b>Simple Calculations .....</b>	<b>19</b>
Pointing mode .....	7	Length .....	19
Measuring mode .....	7	Total height, total distance .....	19
<b>Instrument description .....</b>	<b>8</b>	Partial heights, partial distances .....	19
Standard equipment .....	8	Doubling a measured value .....	19
Basic instrument .....	9	Area .....	20
Display .....	10	Volume .....	20
Special symbols .....	10	<b>Menu Functions .....</b>	<b>20</b>
Keypad .....	11	Measurement settings (1) .....	20
Overview .....	11	Measurement reference (1.1) .....	20
Table of characters .....	11	Add / Subtract (1.2) .....	21
Inserting / replacing the batteries .....	13	Time delay release (1.3) .....	22
<b>How to use instrument .....</b>	<b>13</b>	Laser (1.4) .....	23
Switching on DISTO .....	14	Tracking (1.5) .....	24
Switching on DISTO for the first time .....	14	Data transfer (1.6) .....	24
Switching on Pointing mode .....	14	End covers (2) .....	24
Switching off DISTO .....	15	Without end cover (2.1) .....	24
Measuring .....	15	Adapter end cover (2.2) .....	25
Using menus .....	15	Recognition (2.3) .....	26
Selecting menus / menu functions .....	15	Swivel foot (2.4) .....	26
Short cut .....	16	Alignment aid (2.5) .....	27
Correct menu selection .....	16	Basic settings (3) .....	27
Reset menu functions .....	16	Units (3.1) .....	27
Quit menu .....	16	Language (3.2) .....	28
Using end covers .....	16	Beep (3.3) .....	28
Automatic end cover recognition .....	16	Reset (3.4) .....	28
Changing end covers .....	17	Lighting (3.5) .....	28
		Switch off (3.6) .....	29

Basic functions (4) .....	29	Accessories .....	52
Maximum tracking (4.1) .....	29	Accessories for measurements .....	52
Minimum tracking (4.2) .....	29	Accessories for data interface .....	53
Required distance (4.3) .....	30	Transport accessories .....	53
Pythagoras (4.4) .....	33	<b>Safety Instructions .....</b>	<b>53</b>
Height (4.5) .....	35	Use of the Instrument .....	53
Accuracy (4.6) .....	36	Permitted use .....	53
Average value (4.7) .....	36	Prohibited uses .....	53
Calculation (5) .....	37	Limits to use .....	54
Triangle SSS (5.1) .....	37	Areas of Responsibility .....	54
Triangle SH (5.2) .....	38	Hazards in Use .....	54
Trapezium HSH (5.3) .....	39	Important hazards in use .....	54
Trapezium HSD (5.4) .....	40	Laser Classification .....	55
Gable area (5.5) .....	41	Labelling .....	56
Circle (5.6) .....	42	DISTO with Telescopic Viewfinder .....	56
Space (5.7) .....	43	Electromagnetic Compatibility (EMC) .....	56
Memory (6) .....	44	FCC Statement (applic. in U.S.) .....	57
1 - 9 recall key (6.1) .....	44	<b>Care and Storage .....</b>	<b>58</b>
1 - 9 recall key (6.2) .....	45	Care .....	58
Stack (6.3) .....	46	Clean and dry .....	58
Data (6.4) .....	47	Storage .....	58
Calculator (7) .....	50	Transport .....	58
Division (7.1) .....	50	Despatch .....	58
$x^2$ (7.2) .....	50	<b>Technical Data .....</b>	<b>59</b>
Square root (7.3) .....	50	Remarks on Measuring Accuracy .....	60
<b>User Information .....</b>	<b>51</b>	Possible method of calculating the standard deviation s: .....	60
Range .....	51	Accuracy Tests .....	60
Rough surfaces .....	51	<b>Message Codes .....</b>	<b>61</b>
Transparent surfaces .....	51	<b>Short cut index .....</b>	<b>62</b>
Wet, smooth and high-gloss surfaces .....	51		
Inclined, round surfaces .....	51		
Free- handed aiming .....	51		
Measuring in the field .....	51		
Setting viewfinder .....	51		

## Introduction

*DISTO™ pro<sup>4</sup>* and *DISTO™ pro<sup>4</sup> a*, the top of the line of the new DISTO series, offer the most in measuring comfort.

These instruments are perfectly suited for quick width and distance measurements, followed by computations of partial distances, areas, volumes, etc.

The three end covers supplied are used to set the desired measurement references (for corners, angles, edges, tripod, etc.).

## Special features

- Robust; proven reliability on construction sites
- Clear, lit displays
- Alphanumeric keypad
- Integrated pocket calculator, extensive functions for calculations
- User friendly menus with short cuts
- Memory allocation for up to 800 measured values
- Language selection and selectable measuring units
- Integrated interface for data transfer to a PC
- *DISTO™ pro<sup>4</sup> a*: the utmost in measuring accuracy of the DISTO series

## Area of applicability

This User Manual is valid for both types, *DISTO™ pro<sup>4</sup>* and *DISTO™ pro<sup>4</sup> a*.

References made in this manual to the product name DISTO, are valid for both instrument types.

## Modes of operation

### Normal mode

DISTO is on, but the laser is not operating. This mode is for making entries, carrying out calculations and calling up menus.

### Pointing mode

DISTO is on, the laser is operating. Objects to be measured can be pointed at in this mode.

### Measuring mode

DISTO is on and performs single or continuous measurements (e.g. minimum and maximum tracking, staking out, etc.).

en

## Instrument description

## Standard equipment

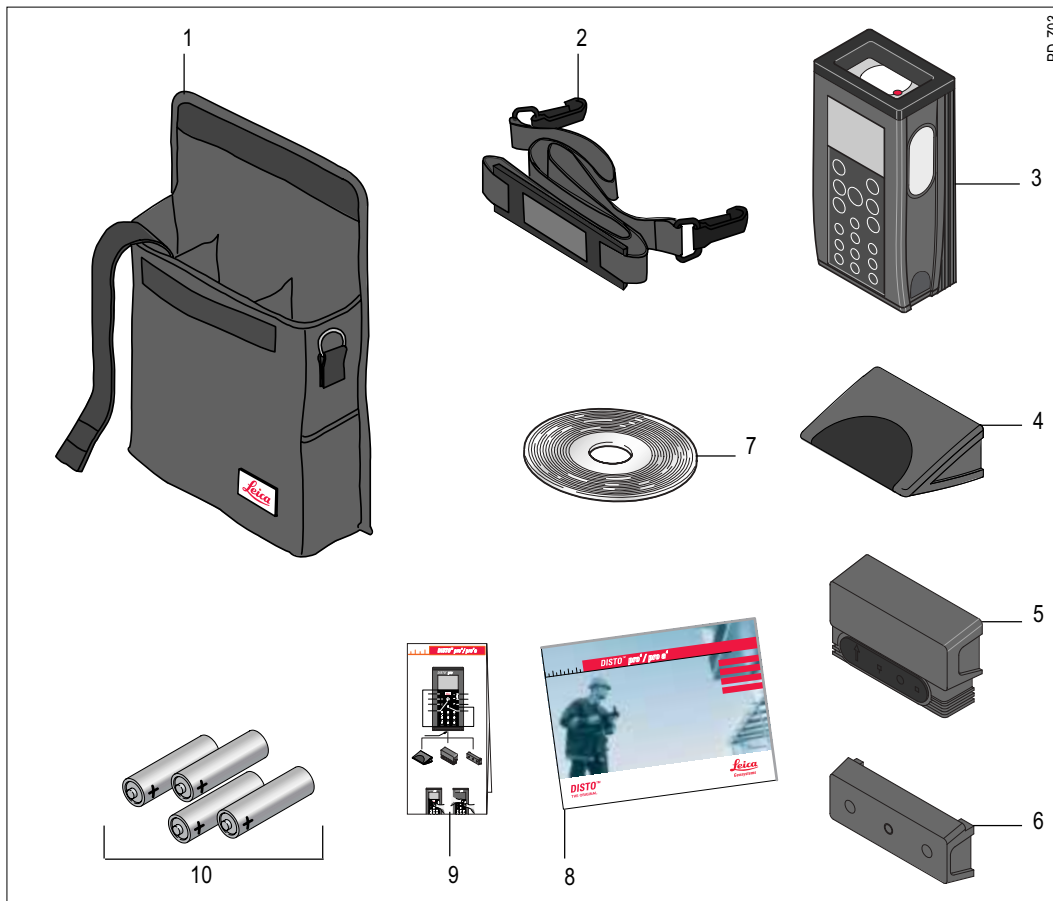

- 1 Carrying case with belt loop at the back
- 2 Waistband
- 3 DISTO™ pro<sup>4</sup> / DISTO™ pro<sup>4</sup> a
- 4 End cover with swivel foot
- 5 End cover with positioning bracket/alignment aid
- 6 Adapter end cover
- 7 CD-ROM with interface software and online documentation
- 8 User Manual
- 9 Quick Guide
- 10 Batteries (4 x 1.5V, AAA)

Additional accessories can be found under User Information.

## Basic instrument

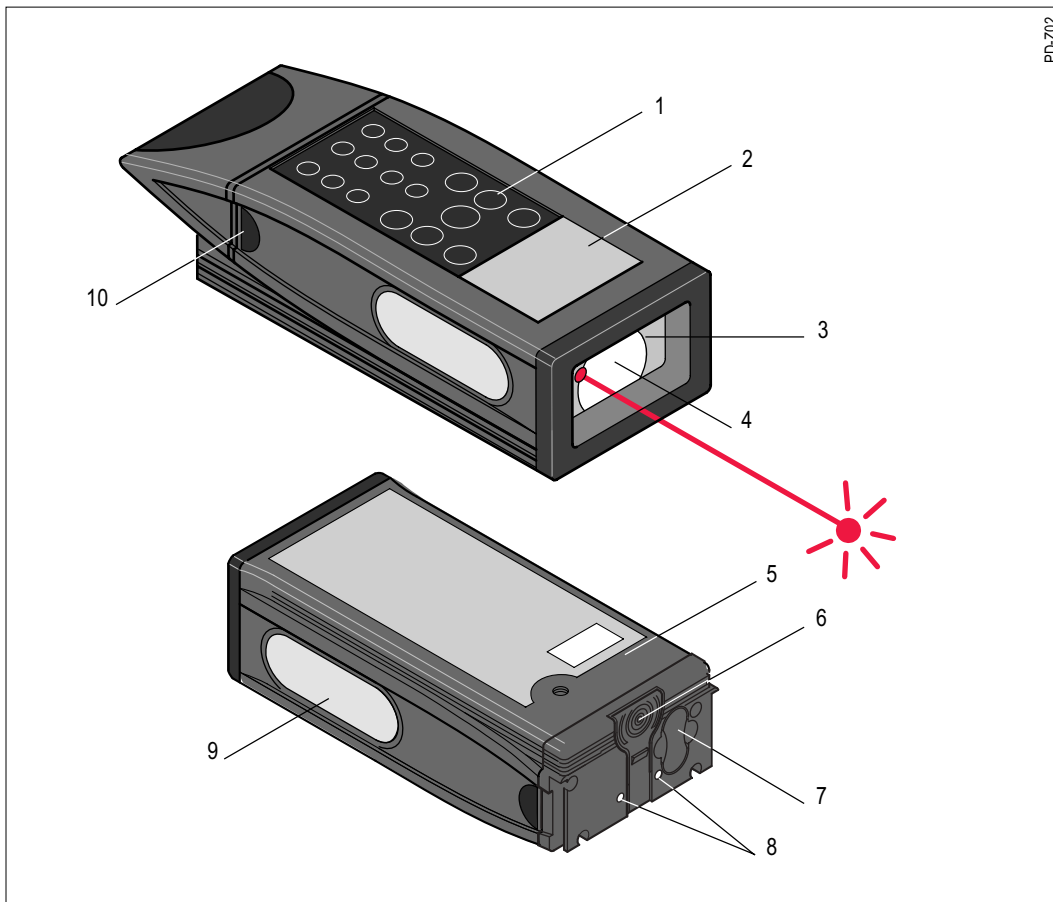

- 1 Alphanumeric keypad
- 2 LED display
- 3 Measuring optics
- 4 Laser beam exit
- 5 Stand connection
- 6 End cover release button
- 7 Battery compartment cover
- 8 Sensors for automatic end cover recognition
- 9 Magnetic plate for attaching accessories
- 10 Interface slot cover

en

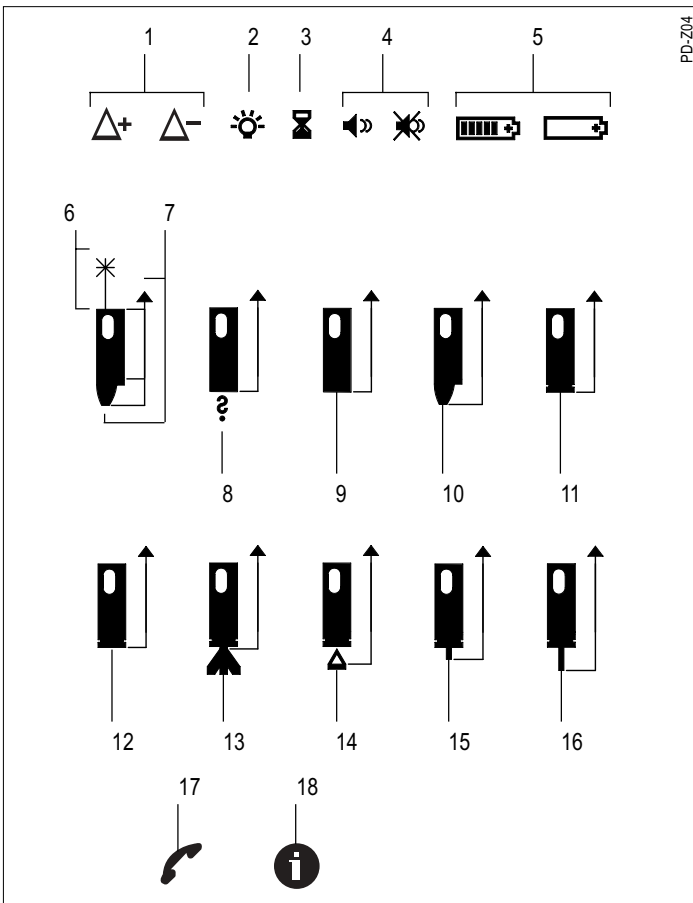

PD-Z04

## Special symbols

- 1 Offset addition / subtraction
- 2 Lighting
- 3 Time delay release
- 4 Beep on / off
- 5 Battery full / empty
- 6 Laser active
- 7 Measurement reference (front, stand, rear)
- 8 DISTO without detected end cover
- 9 DISTO without end cover (menu setting)
- 10 End cover with swivel foot
- 11 End cover with positioning bracket/alignment aid
- 12 Adapter end cover without attachments
- 13 Adapter end cover with stand
- 14 Adapter end cover with free end
- 15 Adapter end cover with short bracket (723775)
- 16 Adapter end cover with long bracket (723776)
- 17 Contact service centre
- 18 Error message



# Keypad

## Overview

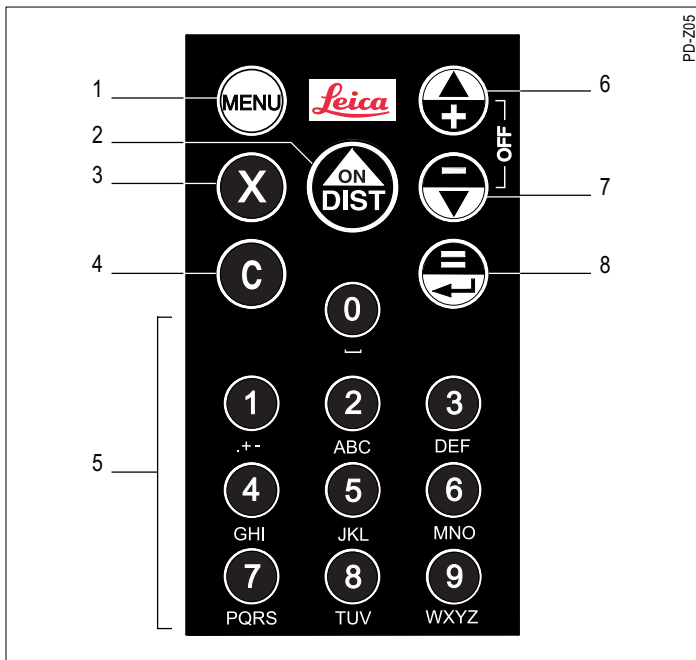

- |                                       |                                |
|---------------------------------------|--------------------------------|
| 1 Menu key                            | 6 Plus / navigation key, up    |
| 2 Power on and measuring key          | 7 Minus / navigation key, down |
| 3 Multiplication / time delay release | 8 Result / Enter key           |
| 4 Clear key                           |                                |
| 5 Alphanumeric keypad 0-9             |                                |

## Table of characters

Key	assigned characters												
1	.	+	-	,	?	!	&	1					
2	A	B	C	2	Ä	À	Á	Â	Ã	Ä	Æ	Ç	
	a	b	c	2	ä	à	á	â	ã	ä	æ	ç	
3	D	E	F	3	É	È	Ê	Ë					
	d	e	f	3	é	è	ê	ë					
4	G	H	I	4	Ì	Í	Î	Ï					
	g	h	i	4	ì	í	î	ï					
5	J	K	L	5									
	j	k	l	5									
6	M	N	O	6	Ö	Ñ	Ò	Ó	Ô	Õ	Ø		
	m	n	o	6	ö	ñ	ò	ó	ô	õ	ø		
7	P	Q	R	S	7								
	p	q	r	s	7								
8	T	U	V	8	Ü	Ù	Ú	Û					
	t	u	v	8	ü	ù	ú	û					
9	W	X	Y	Z	9								
	w	x	y	z	9								

This table contains all displayable characters that can be entered through the keypad.

 The symbols on the keys are limited to the most commonly used characters, due to the lack of space.

## Keypad, contd.

### Menu key

To call up the main menu.

After entering a numeric value through the keypad, (multiple) presses on the menu key adds the desired unit (e.g. m, m<sup>2</sup>, m<sup>3</sup>).

### Power on and measuring key

Pressing the power on and measuring key in Normal mode switches the laser to permanent operation (1.4.2).

Pressing the power on and measuring key in Pointing mode starts continuous measurement (Tracking, 1.5.1) or, if using certain menu functions maximum (4.1) or minimum tracking (4.2).

 A tangible elevation in the middle of the keys facilitates correct key presses e.g. in darkness.

### Multiplications / Time delay release

To multiply two or more measured or numeric values (see section "Simple calculations").

A brief press in Pointing mode starts the time delay release; pressing and holding increases time delay. Upon release the timer starts.

To switch between capital and small letters during text input.

### Clear key

A brief press (Clear Entry) deletes the last entry or the intermediate result of a computation.

 During computations within a menu function or in selecting a menu setting the last display or input is deleted as long as the result / enter key has not been pressed.

Briefly press clear key one or more times to move backward through the menu.

 Press clear key for a long period to quit the menu section and to return to the basic settings in normal mode.

### Alpha numeric keypad 0-9

The 0 key displays a blank space. The 1-9 keys represent characters (see Table of characters).

The availability of these characters depends on the currently selected function.

### Input of numbers

Assigned text characters of the keys are blocked.

Key 1 pressed twice briefly enables:

- a minus sign to be input as the first character,
- a decimal point to be placed after having entered at least one number.

A long press on the 0 key calls up memory allocations for the input values:

- Press 0 until a beep sounds (approx. 1 sec). After release, the contents of keypad memory 1 is displayed.
- Press 0 until two beeps sound (approx. 2 sec). After release, the first memory contents of the stack is displayed.

 Detailed information can be found in the section Menu functions under "Memory".

### Text or data input in the data memory

Brief repeated presses on the keys displays the different layers of assigned characters.

Example: 1 x key 2 = A / a  
2 x key 2 = B / b, etc.

 Briefly press to switch between capital / small letters.

## Keypad, contd.

After a long pause or by pressing another key the cursor changes to the next display.

 If one of the 0-9 keys are pressed for a long time, its number appears on the screen.

### **Result (=) / Enter key**

Press briefly to:

- finalize a computation and to display the result.
- end a menu function and display the result.
- confirm an input or setting.
- confirm a single measurement in the menu function.
- jump from the menu to the selected sub menu.

 Press and hold to save a value into the data memory. With menu functions, all results are saved in sequence to the data memory.

### **Plus / navigation key (up)**

### **Minus / navigation key (down)**

Press respective keys briefly in normal mode to:

- enter an addition or subtraction in a computation
- move up or down from one entry to the next in menus.

Press respective keys briefly in Pointing mode to change measurement reference.

 Press both keys simultaneously to turn DISTO off in Normal and Pointing mode.

 Or as an alternative, press and hold one of the keys and then press the other.

## How to use instrument

For a first time use, insert new batteries into the DISTO (for battery type read the technical data sheet).

 This symbol appears in the display as soon as the batteries are empty and need to be replaced.

 When changing batteries, the settings and saved measured values remain unchanged in the data memory.

## Inserting / replacing the batteries

1. Press end cover release button, and pull the end cover off the instrument.

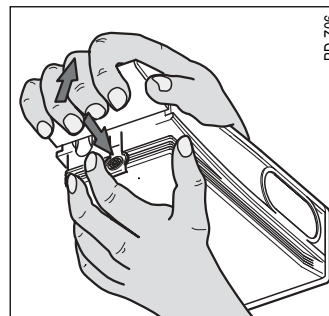

2. Press both locking clips together with fingertips and pull out battery cover.

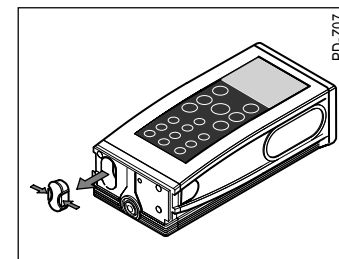

3. Remove empty batteries, if any. Fit new batteries the right way round.

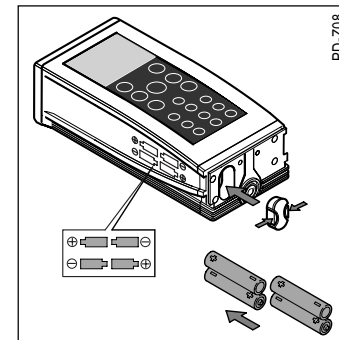

## Insert / replace batteries, contd.

### IMPORTANT:

- The proper way of inserting the batteries is shown on the side of the battery compartment.
  - Always replace the entire set of batteries. Never mix old and new ones.
  - Never use batteries made by different manufacturers or batteries of different type.
4. Replace battery cover.
  5. Place end cover in slot and push in until it locks.

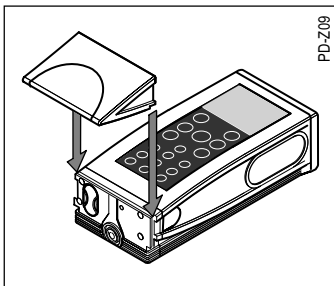

### Switching on DISTO

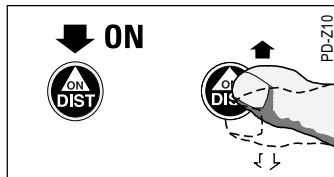

 Press briefly.

DISTO is on and in normal mode. The display shows the basic settings with the last measured value.

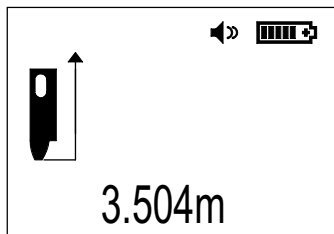

### Switching on DISTO for the first time

When following the described procedure, the language selection menu is displayed first.

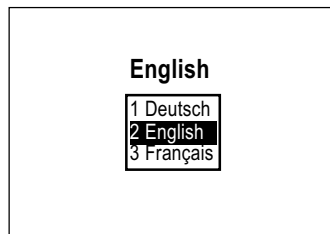

 Select desired language with these keys.



A horizontal bar marks the selection.



A brief press confirms the selection.

After a "Thank you" text, the basic settings display appears.

Language selection can be changed at any later time in menu "Language" (3.2).

It is possible to load an additional fourth language via the DISTO interface.

Any further language loaded via the interface after the fourth one, automatically replaces that fourth loaded language.

Read instructions for the DISTO Online Software on the CD-ROM supplied.

### Switching on Pointing mode

 Briefly press.

DISTO changes from Normal mode into Pointing mode and the laser lights up.

 This symbol appears in the basic settings display while the laser is on.

If within 30 seconds no measurement is triggered the laser turns off automatically to save batteries. DISTO is then back in Normal mode.

 Press again to start laser and to switch into Pointing mode.

## Switching off DISTO

To save batteries, the DISTO automatically switches off after 90 seconds if no key is pressed in that time, or it is not in Permanent mode.

Manually, the DISTO can be switched off in different ways .

### 1. In Normal mode

 Press both keys simultaneously or hold one of both keys and then press second key.

or select menu function "Switch off" (3.6) :

 Press briefly.

 Enter short cut.

### 2. In Pointing mode, in a menu function, etc.:

 Press one or more times until the basic settings in Normal mode are displayed.

 Then press both keys simultaneously or hold one of both keys and then press second key.

## Measuring

### Switch on DISTO

 Press briefly.

DISTO is in Normal mode.

### Distance measurement

 Press again briefly to activate Pointing mode.

Aim at object to be measured.

 Press again to trigger distance measurement

The result is displayed in the selected unit.

## Using menus

From the main menu, various submenus can be called up from which functions can be selected (refer to short cut index).

### Selecting menus / menu functions

 Press briefly in Normal mode to display the main menu.

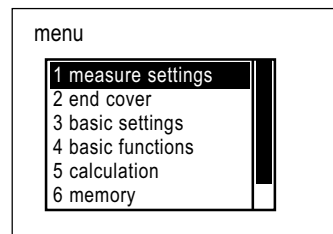



The upper line of the main menu shows the selected menu item with numeric short cut.

The horizontal black bar marks the selected menu item. If all menus are not displayable at once, a vertical roll bar appears at the right side, indicating the availability of further items.

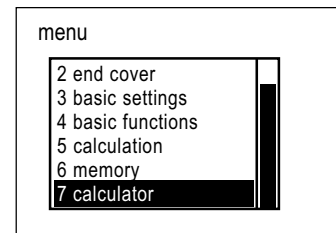
 Repeated presses scrolls down and highlights the individual menu items.



 If required, press repeatedly to scroll up to get back to individual menu items.

 A brief press confirms selection.

Now a submenu appears or a beep sounds, while briefly displaying a confirmation.

## Using menus, contd.

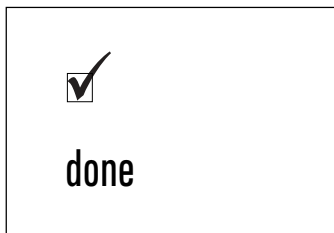

en

### Short cut

Each submenu function has a numeric code, a so called short cut number.

By entering the short cut number, a submenu or a menu function can be selected directly.

 Short cut numbers are listed in brackets when menus or menu functions are being described (e.g. 1.4.2). An overview of short cut numbers can be found in the short cut index and in the Quick Guide.

 Press briefly .

 Enter short cut number, e.g. 1-4-2 for permanent laser operation.

Submenus appear step-by-step until the desired menu function.

After the completion of the entry of the short cut number the menu function is carried out and a brief confirmation is displayed.

 Use the short cut to save time when calling up frequently used menu functions.

### Correct menu selection

 Press briefly to display the previous menu.

### Reset menu functions

The "Reset" command (3.4) enables settings and menu functions to be reset to a predefined basic setting. The basic settings are listed in the description of the menu functions.

### Quit menu

 Press and hold to quit menu and to display basic settings in Normal mode.

## Using end covers

DISTO is delivered with the swivel foot end cover already attached. Two additional end covers and accessories, available as options, enable the instruments to be adapted to varying measuring situations.

### Automatic end cover recognition

Magnetic sensors at the back of the instrument make it possible to recognize if an end cover with swivel foot or positioning bracket/alignment aid has been attached.

The instrument symbol in the basic settings display includes the symbol of the detected end cover and measurement is referenced accordingly.

 Automatic end cover recognition

- does not work with the adapter end cover,
- does not change the preset measurement reference.

Automatic end cover recognition can be switched off with menu function "Recognition off" (2.3.2).

## Using end covers, contd.

In this case, the end cover has to be manually selected in the submenu "End covers" (2).

**CAUTION:**  
Strong magnetic fields can influence end cover recognition and cause measuring errors.

**Precautions:**  
Measurements near magnetic fields, e.g. magnets, transformers... should be done with the automatic end cover recognition switched off and measuring has to be monitored carefully.

### Changing end covers

The procedure for changing end covers is the same for all types.

1. Press release button and pull off end cover.

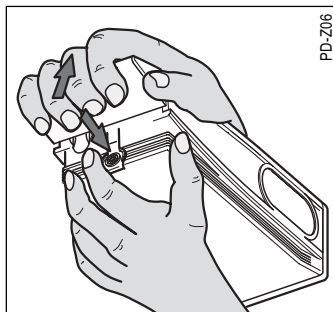

 When using the end cover with positioning bracket / alignment aid the release button is only accessible through the recess in the end cover.

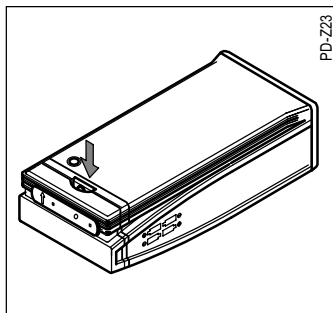

If the menu function "no end cover" (2.1) is not selected, then as soon as a measurement is tried without an end cover, a message is displayed.

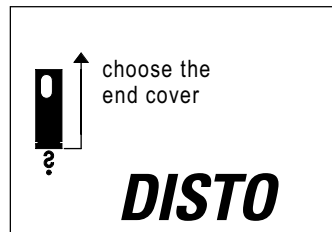

2. Select and place an end cover in the slot of the casing and push it down until it locks.

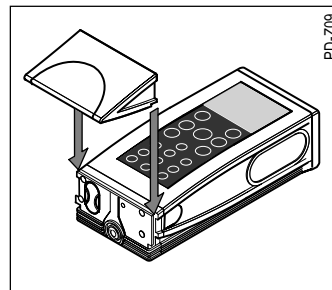

3. A short confirmation is displayed and then the basic mode. The DISTO is ready for measurement.

**CAUTION:**  
Wrong measurements after changing end covers.  
**Precautions:**  
Please make a control measurement every time after changing end covers.

For measurements without end cover please enter the menu function "no end cover" (2.1) after removing the end cover.

 Avoid using DISTO without end cover, as this will leave the battery cover exposed and prone to being damaged.

### Measuring from flat planes

For stable measuring turn swivel foot on the end cover by 90°.

## Using end covers, contd.

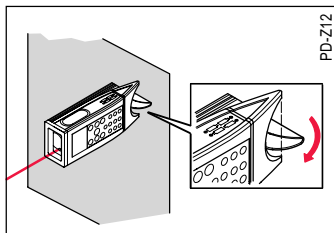

Or use the end cover with folded in positioning bracket / alignment aid.

### Measuring from corners

Exact measurements from corners can only be made with the end cover with swivel foot. Just keep the swivel foot in its initial position (aligned with the edge of the end cover).

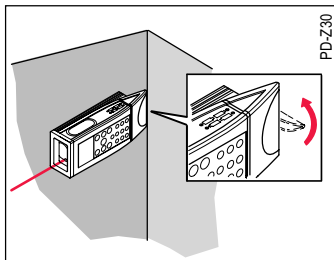

### Measuring from edge

Normally the end cover with the positioning bracket / alignment aid is used.

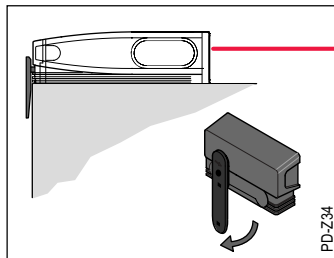

As an auxiliary stop, the opened closing cap of the interface plug can be used.

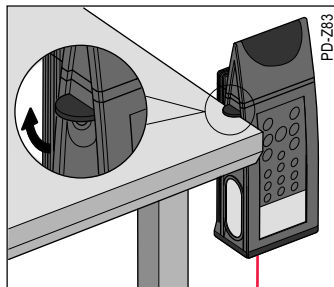

The stand as measuring reference must be entered, when using the auxiliary stop.

### Measuring with alignment aid

The DISTO is ideally suited for "marking-off ops." - e.g. when staking out distances.

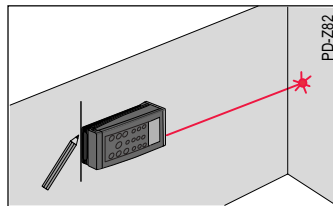

### Measuring with stand

Using a stand eliminates shaking when measuring over a long distance.

The stand connection on the bottom of the casing of the DISTO is normally used.

 The thread of the stand should not be longer than 5.5 mm or it could damage the casing of the DISTO.

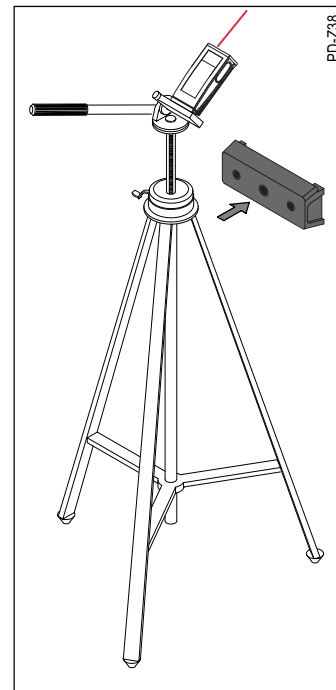



## Using end covers, contd.

### Measuring with accessories

The adapter end cover has two threads for attachments (e.g. customer specified end covers).

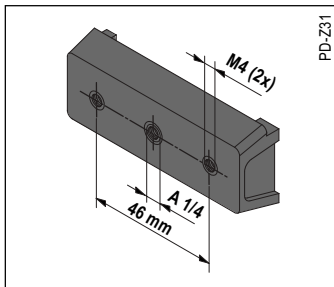

Optional measurement attachments:

- Short bracket (723775)
- Long bracket (723776)

Read user information under "Accessories".

The DISTO has special menu functions (2.2.2 and 2.2.3), to set measuring references with these optional devices.

 To use the DISTO in high and hard to reach places, attach the extendable telescopic rod to the stand's connection.

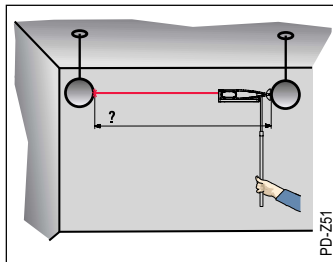

## Simple Calculations

Sequential measurements can be linked using mathematical functions or input values.

### Corrective measures





-  A brief press deletes/repeats the last entry, an intermediate result or a faulty measured value.

 Corrections are only possible if the Result / Enter key has not been pressed.

### Length

#### Total height, total distance





Measurement + measurement = **sum**

-  Measurement
-  Addition
-  Measurement
-  = Sum

 In the same way **chain measurements** (any amount of distance measurements) and **sums of areas / volumes** can be added up.





### Partial heights, partial distances

Measurements - measurements = **difference**

-  Measurement
-  Subtraction
-  Measurement
-  = Difference



### Doubling a measured value

It is easy to double the measured value to obtain, e.g. the circumference of a room:

-  Measurement
-  Addition
-  Measurement
-  = Sum  
(half circumference)

en





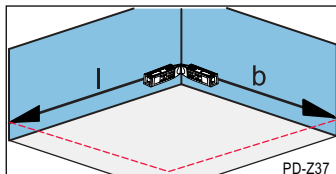

## Length, contd.

-  Repeat, double measured value
-  = Sum (circumference)



## Area





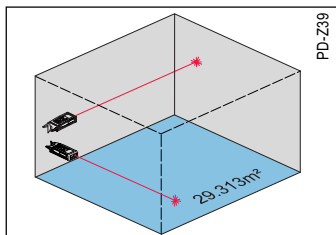



Measurement x measurement = **area**

-   Measurement (e.g. 3.500m)
-  Multiplication
-   Measurement (e.g. 8.375m)
-  = Area (e.g. 29.313m<sup>2</sup>)



## Volume

Measurement x measurement x measurement = **volume**

-   Measurement (e.g. 3.500m)
-  Multiplication
-   Measurement (e.g. 8.375m)
-  Multiplication
-   Measurements (e.g. 2.285m)
-  = Volume (e.g. 66.980m<sup>3</sup>)

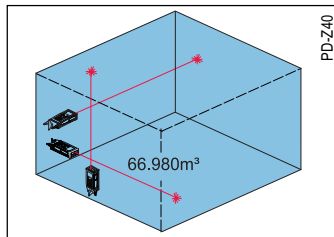

 The volume can also be computed following an area calculation.

## Menu Functions

Menu functions are described in the sequence of their appearance on the DISTO display, i.e. in an ascending order of their respective short cut numbers.

The short cut numbers are listed in brackets behind the menu function.

How to use the menus is explained in section "How to use the instruments" under "Using menus".

 The short cut numbers facilitate searching for menu functions.

### Measurement settings (1)

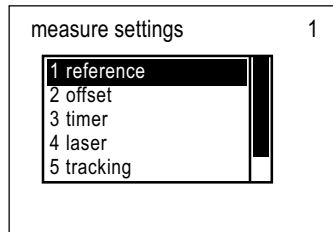
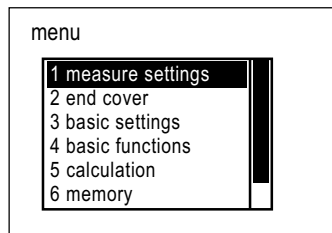

### Measurement reference (1.1)

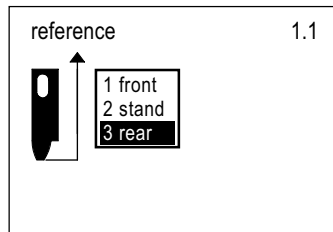



Set measurement reference for the DISTO, showing where measurements will be made from. The set measurement reference is used for all following measurements until the it is changed again.

Basic setting: Rear (1.1.3)

## Measurement settings, contd.

The measurement reference symbol in basic mode has a referencing line and an arrow.

 In Pointing mode the measurement reference can be changed with the (+/-) navigation keys. The next measurement is made from the changed reference and after that from the preset reference.

 **Front (1.1.1)**  
Measurement from the front of the instrument (Measuring optics).

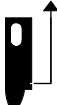
 **Stand (1.1.2)**  
Measurement from the stand connected to the rear of the instrument.

This setting is also used when the closing cap of the interface acts as an auxiliary stop.

 **Rear (1.1.3)**  
Measurements from the rear edge of the end cover.

The DISTO automatically adjusts the reference to the attached end cover. Read more in section "Using end cover" and menu function "End cover recognition on" (2.3.1).

After selecting and entering a measurement reference, a short confirmation appears and the menu is terminated. The DISTO changes to Normal mode and displays the basic settings

### Add / Subtract (1.2)

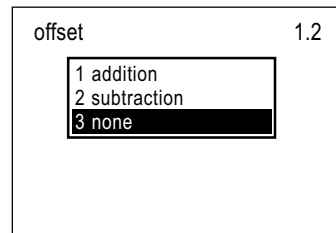

This adds or subtracts to / from measurements. Tolerances can be taken into consideration, e.g. between unfinished and finishing dimensions.

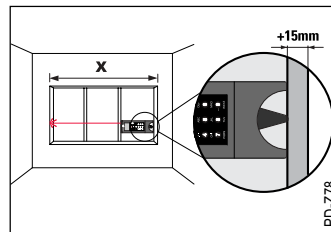



Default setting: None(1.2.3)

 **CAUTION:**  
After every input of or change in Add / Subtract, carry out a control measurement.

Save frequently used Add / Subtract functions in the keypad memory and call them up when needed.

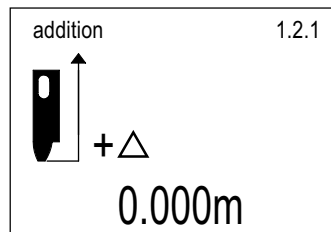
**Addition (1.2.1)**  
After calling up this menu function the following is displayed.



  Enter Add with keypad, recall it from the keypad or stack memory.

 Press briefly to display the units of Add.

 Meters are automatically added without having to press the menu key.

 Press briefly to confirm entered addition.

 Press briefly again to terminate menu function.

A short confirmation is displayed.

 DISTO switches to Normal mode and displays in the uppermost line of basic setting the symbol of the addition.

## Measurement settings, contd.

Add

- is valid for all following measurements,
- is automatically suggested at the next menu function call up.

### Subtraction (1.2.2)

After calling up this menu function, the following is displayed.

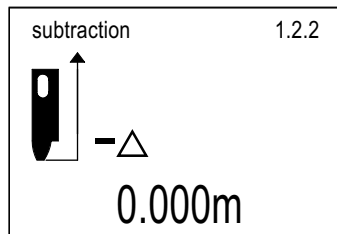

- Enter subtraction with keypad or call it up from the keypad or stack memory.



Do not enter minus sign for subtraction.



Press briefly to display unit of subtraction.



Meters are automatically subtracted without having to press the menu key.



Press briefly to confirm entered subtraction.



Press briefly again to terminate menu function.

A short confirmation is displayed and the DISTO switches to Normal mode.



The uppermost line of the basic setting displays the symbol of the subtraction.

Subtract

- is valid for all following measurements,
- is automatically suggested at the next menu function call up.

### Off (1.2.3)

Deletes an existing addition or subtraction.

After a brief press on the Enter key a confirmation appears and the menu is quit.

The DISTO changes into Normal mode and displays the basic settings.

### Time delay release (1.3)

Sets time delay between 5 - 60 seconds after pressing the trigger key to the start of the measurement.

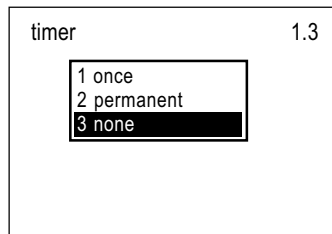

Default setting: None (1.3.3)

The time delay release permits using the DISTO in measuring situations where the keypad is hard to reach.



This symbol appears in the uppermost line of the basic settings when the time delay release is in use.

### Once (1.3.1)

After calling up the menu function, the following is displayed.

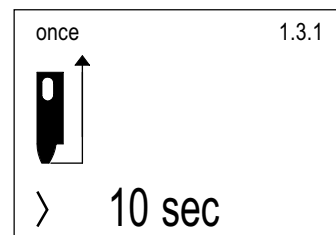

The suggested delay is only for the next single measurement and can be changed as follows:



With the navigation keys.



Each key press increases, respectively decreases delay by 1 second.



With a keypad entry.



As long as this key is pressed the delay increases until the maximum of 60 seconds is reached.

## Measurement settings, contd.

After a brief press on the Enter key a confirmation appears and the menu is terminated.

The DISTO changes into Normal mode and displays the symbol of the time delay release in basic settings.

The delay can also be set in the Pointing mode:

- ⓧ Keep pressed, until the desired delay is reached.

The uppermost line displays the symbol of the time delay release with the delay below it.

Upon release the remaining seconds to the measurement is displayed (e.g. 59, 58, 57,...). The last 5 seconds are counted down with a beep sound. After the last beep the measurement takes place and the measured value is displayed.

### Permanent (1.3.2)

After calling up this menu function, the following is displayed:

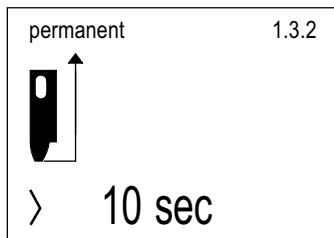

The suggested delay is for all following measurements and can be changed as follows:

- ⬆ With the navigation keys. Each key press increases, respectively decreases delay by 1 second.
- 0 9 With a keypad entry.
- ⓧ As long as this key is pressed the delay increases until the maximum of 60 seconds is reached.

After a brief press on the Enter key a confirmation appears and the menu function is terminated.

The DISTO changes into Normal mode and displays the symbol of the time delay release in basic settings.

### None (1.3.3)

After pressing the Enter key the permanent delay is deleted and the menu function terminated.

### Laser (1.4)

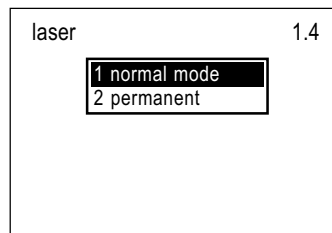

Here the operational mode of the laser is set.

Normal mode: The laser switches off automatically after 30 seconds.

Permanent mode: The laser remains on in Pointing mode as long as the DISTO is on.

Default setting: normal (1.4.1)

### Normal mode (1.4.1)

After pressing the Enter key the menu function is terminated and basic settings are displayed.

- \* This symbol appears in basic settings as long as the laser is on.

### Permanent (1.4.2)

After pressing the Enter key the menu is terminated and basic settings are displayed and the Permanent mode is started.

Every press on the On and measurement key immediately triggers a measurement.

- \* This symbol is permanently displayed in basic settings.

☞ Only activate permanent mode of laser if required as it uses up battery power very rapidly.

## Measurement settings, contd.

### Tracking (1.5)

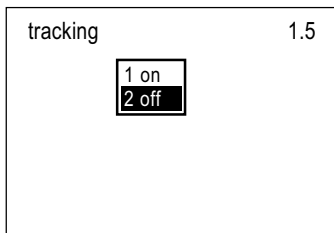

Tracking for the DISTO is selectable in this submenu.

This function permits moving objects to be measured and stake outs placed to a fixed object.

Default setting: off (1.5.2)

#### On (1.5.1)

After pressing the Enter key, a short confirmation appears and the menu function is terminated.

DISTO changes to Normal mode and displays the basic settings with "Track" appearing in the uppermost line.

Tracking is started by pressing the trigger key twice.

The lowest line displays the continuously updated measured value.

A brief press on the trigger key ends tracking. The most recent measured value can now be saved or used in a computation.



Frequent and long tracking uses up battery power very rapidly.

#### Off (1.5.2)

After pressing the Enter key, a short confirmation appears and the menu function is terminated.

The DISTO changes to Normal mode and displays the basic settings.

### Data transfer (1.6)

This submenu permits immediate data transfer from the DISTO via the data interface to a PC or a laptop.

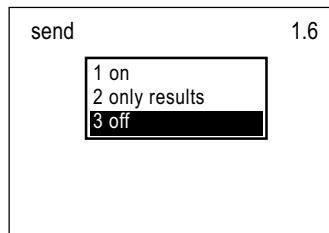

Default setting: off (1.6.3)

#### On (1.6.1)

All measurements and calculations are transferred; the data interface transfers data continuously.

#### Only results (1.6.2)

Only measurement or calculation results (e.g. at maximum or minimum tracking) are transferred.

#### Off (1.6.3)

The data interface is off.



These menu functions are described in the Online-documentation on the CD-ROM supplied.

## End covers (2)

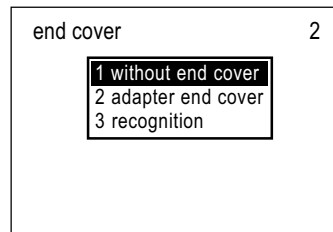
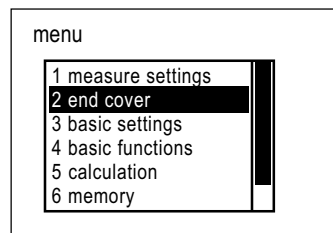



### Without end cover (2.1)

This menu function permits the use of the DISTO without end cover.

After pressing the Enter key a short confirmation appears and the menu function is terminated.

## End covers, contd.

 DISTO changes to Normal mode and displays basic settings. The symbol for the instrument without end cover appears.

 Avoid using DISTO without end cover as the battery cover is then exposed and may be damaged.

### Adapter end cover (2.2)

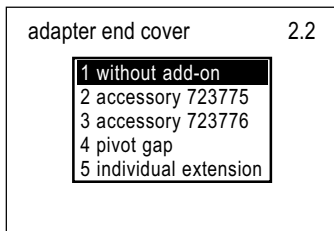

The settings for how the adapter end cover will be used are made here. These settings determine the rear reference of the DISTO.

Default setting: none, meaning that after a reset all settings remain.

### Without add-on (2.2.1)

Select this menu function when the adapter end cover is used without any further add-ons.

After pressing the Enter key a short confirmation appears and the menu function is terminated.

 DISTO changes to Normal mode and displays the symbol of the adapter end cover in the basic settings.

### Accessory 723775 (2.2.2)

This menu function sets rear reference to the adapter end cover with the optional short bracket (read User Information, Accessories).

After pressing the Enter key a short confirmation appears and the menu function is terminated.

 DISTO changes to Normal mode and displays the basic settings. The symbol of a special adapter appears.

### Accessory 723776 (2.2.3)

This menu function sets rear reference to the adapter end cover with the optional long bracket (read User Information, Accessories).

After pressing the Enter key, a short confirmation appears and the menu function is terminated.

 DISTO changes to Normal mode and displays basic settings. The symbol of a special adapter appears.

### Set pivot gap (2.2.4)

Set pivot gap in this menu function when a stand is used with the adapter end cover.

To adjust rear reference, the distance from the rear side of the adapter end cover to the rotation axis of the stand has to be entered.

 For stand SLIK U9000, recommended for use with DISTO, this distance is 0.054 m.

After calling up the menu function, the following is displayed:

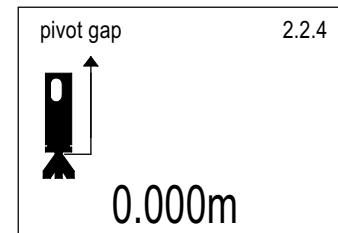

The last saved entry for the pivot gap between adapter end cover and the rotation axis of the stand is displayed.

Enter new pivot gap with keypad, recall value from keypad memory or from the stack.



Brief press confirms entry.



Renewed press quits menu.

A short confirmation is displayed and the DISTO changes to Normal mode.

## End covers, contd.

 Distances entered are only considered, when measuring reference is set to rear.

### Individual extension (2.2.5)

Menu function mean for add-ons that are customer specified or for extensions to adapter end covers.

To adjust the rear reference, the distance from the adapter end cover to the locating surface of the customer specified add-on has to be entered.

 It is possible to enter negative values.

After calling up the menu function the following is displayed:

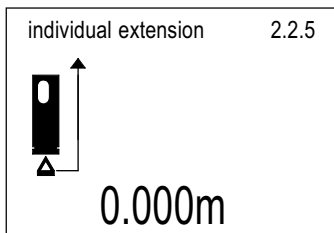

The most recently entered distance between adapter end cover and the individual extension is displayed.

Enter new distance with the keypad, recall it from the keypad memory or from the stack



Brief press to confirm entry.



Renewed press to quit menu function.

DISTO changes to Normal mode and displays basic settings. The symbol for individual extension appears.



Distances entered are only considered when reference is set to rear.

### Recognition (2.3)

Automatic end cover recognition is switched on and off in this submenu.

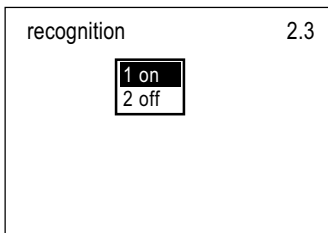

Automatic recognition only works with end covers with swivel foot or positioning bracket / alignment aid. Read section "Using end covers".

Default setting: on (2.3.1)

#### On (2.3.1)

Automatic recognition is on.

After pressing the Enter key a short confirmation appears and the menu function is terminated.

DISTO changes to Normal mode and displays basic settings. The symbol of the detected end cover appears.

#### Off (2.3.2)

Turns automatic recognition off.

After pressing the Enter key, a short confirmation appears and the menu function is terminated.

DISTO changes to Normal mode and displays basic settings. The symbol of the most recently detected or entered end cover appears.



For each new end cover, the respective menu function must be entered.

#### Rotating foot (2.4)

This menu function

- sets rear reference to the end cover with swivel foot,
- only appears when automatic end cover recognition is turned off.



## Basic settings (3)

After pressing the Enter key, a short confirmation appears and the menu function is terminated. DISTO changes to Normal mode and displays basic settings.

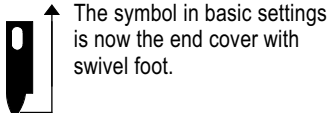

The symbol in basic settings is now the end cover with swivel foot.

### Aligning aid (2.5)

This menu function  
- sets rear reference for the DISTO to the end cover with positioning bracket / alignment aid,  
- only appears when automatic end cover recognition is turned off.

After pressing the Enter key a short confirmation appears and the menu function is terminated. DISTO changes to Normal mode and displays basic settings.

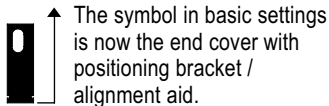

The symbol in basic settings is now the end cover with positioning bracket / alignment aid.

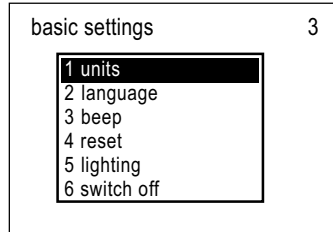
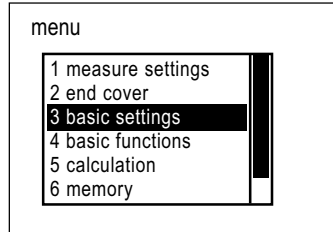
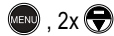

### Units (3.1)

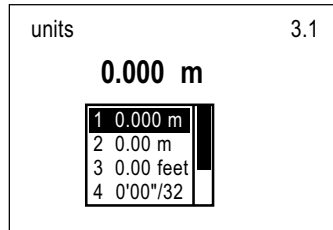

Sets the unit in which DISTO displays measurement and computation results. Additionally, when using the metric system the amount of decimal digits can be set.

Default setting: 0.000 m (3.1.1)

#### 0.000 m (3.1.1)

After selecting this menu function  
- the menu is quit and the basic setting displayed.  
- display is then in meters accurate to three decimals.

#### 0.00 m (3.1.2)

After selecting this menu function  
- the menu is quit and the basic setting displayed.  
- display is then in meters accurate to two decimals.

#### 0.00 ft (3.1.3)

After selecting this menu function  
- the menu is quit and the basic setting displayed.  
- display is then in feet as decimal.

#### 0'00''/32 (3.1.4)

After selecting this menu function  
- the menu function is terminated and the basic setting displayed.  
- display is then in feet and inch.

With inch values, decimals are displayed as fraction of 1/32.

Example: 8.5 inch = 8 in <sup>16</sup>/<sub>32</sub>

#### 0.0 in (3.1.5)

After selecting this menu function  
- the menu function is terminated and the basic setting displayed.  
- display is in inches with one decimal accuracy.

#### 0''/32 (3.1.6)

After selecting this menu function  
- the menu function is terminated and the basic setting displayed.  
- display is in inch.

With inch values, decimals are displayed as fraction of 1/32.

## Basic settings, contd.

### Language (3.2)

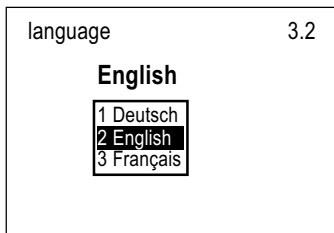

Set language the DISTO uses for messages, settings, etc.

 The language selected for first time use can be changed in this submenu.

Default setting: none

Selectable languages:

**German (3.2.1)**

**English (3.2.2)**

**French (3.2.3)**

 A fourth language can be loaded into the DISTO via the interface (read Online documentation on the CD-ROM supplied).

After pressing the Enter key a short confirmation appears in the selected language and the menu function is terminated.

DISTO changes to Normal mode and displays the selected language in the basic settings.

### Beep (3.3)

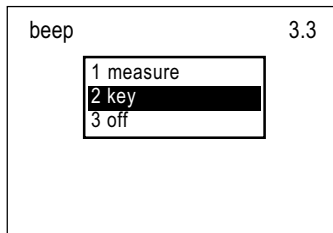

Set a beep to sound for keypresses and / or when measurements are being made.

 /  Beep on / off

One of these symbols will be displayed after switching the DISTO on.

While the symbol for "Beep on" disappears subsequently the symbol for "Beep off" remains permanently displayed.

Default setting: key (3.3.2)

#### Measure (3.3.1)

Every measurement made is confirmed with a beep.

#### Key (3.3.2)

Every key press is confirmed accustically.

#### Off (3.3.3)

Beep is switched off.

 Error messages and switching off the DISTO are always accompanied by a beep.

### Reset (3.4)

Resets customer settings of the DISTO to basic settings.

After pressing the Enter key  
- reset is done immediately,  
- a short confirmation is displayed,  
- the menu function is terminated.

DISTO changes into Normal mode and displays basic settings.

### Lighting (3.5)

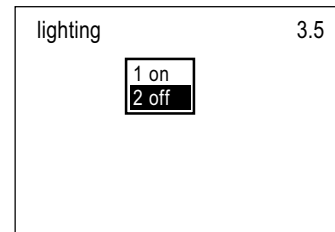

This submenu is used to switch lighting on or off.

Default setting: off (3.5.2)

#### On (3.5.1)

Switches display lighting on.

After pressing the Enter key a short confirmation appears and the menu function is terminated.

## Basic functions (4)

DISTO changes into Normal mode and displays the lit basic settings.

 This symbol appears in the upper most line of basic settings.

 Only use lighting when required as it shortens battery life.

### Off (3.5.2)

Switches off display lighting.

After pressing the Enter key

- the menu function is terminated,
- a confirmation is displayed,
- basic settings are displayed.

### Switch off (3.6)

This menu function switches the DISTO off.

Pressing the Enter key is acknowledged by a beep. Then the DISTO switches off.

 Under "Switching off DISTO" further possibilities to switch off the DISTO are described.

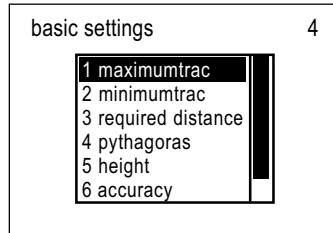
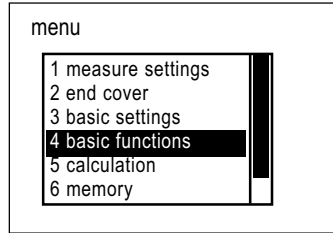
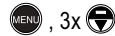

### Maximum tracking (4.1)

Maximum distance measurement is done by using maximum tracking.

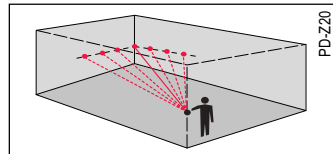

### Application examples:

- measuring room diagonals.
- maximum measures on rough or wavy grounds.
- maximum measures in large halls.
- roof- ridge heights from below the façade.
- in general, where access is difficult or under poor lighting conditions (drainages, shafts, etc.)

After selecting this menu function

- the laser lights up in the Pointing mode,
- the following is displayed.

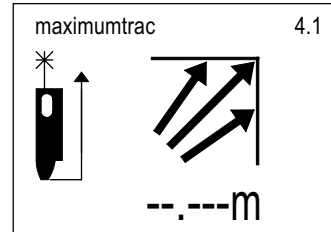

Press briefly to start tracking.

As with the room diagonal:

- aim DISTO first at a point near the opposite corner,
- then move the beam **slowly** across the corner.

 In tracking mode, the DISTO continuously takes single measurements.

The furthest distance is continuously updated and displayed.



Press again to end tracking.

DISTO changes to Normal mode and displays the maximum tracking value in basic settings.

### Minimum tracking (4.2)

Minimum distance measurement is done by using minimum tracking.

## Basic functions, contd.

### Application examples

- measuring clear room ceilings.
- minimum distance measurement in case of rough and wavy surfaces.
- rectangular or horizontal measuring without stand.

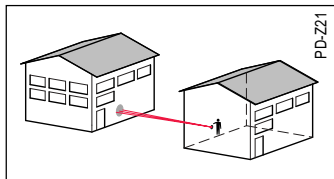

After calling up this menu function  
- the laser lights up in Pointing mode,  
- the following is displayed:

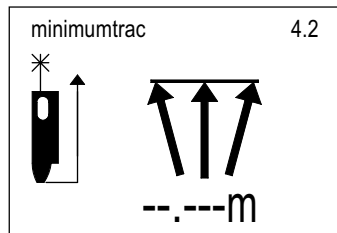

Press briefly to start tracking.



Point DISTO at target. Move DISTO slowly and generously over the target.



In tracking mode the DISTO continuously takes single measurements.

The shortest distance is continuously updated and displayed.



Press again briefly to end tracking.

DISTO changes to Normal mode and displays the minimum tracking value in basic settings.

### Required distance (4.3)

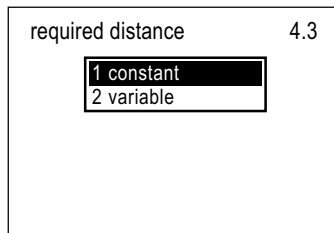

In this submenu fixed or variable distances for staking out can be selected.

After a reset the entered distance values remain unchanged.

In staking out a distance is divided into segments.

The DISTO displays preset distances, starting from a known, aimed at point.

One-by-one these distances can be checked, staked out or marked.

### Application examples:

- Saving the distances between rafters and wooden beams in the DISTO. As a result, the parts can be exactly positioning on the construction site using the DISTO.
- Saving distances of complete developments of walls to the DISTO and check on the site.
- Saving panel sizes in the DISTO and recalling those values during panelling.



These examples also show how to facilitate procedures of checking constructions.

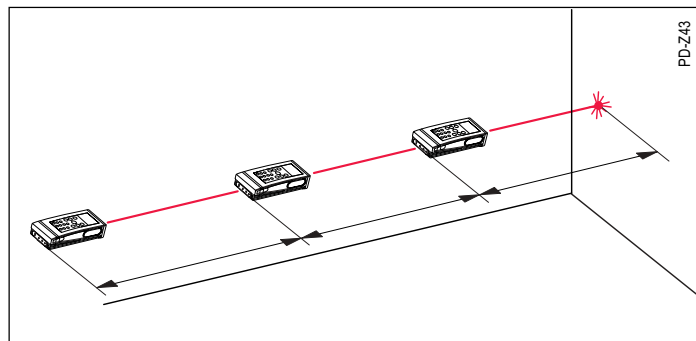

## Basic functions, contd.

### Constant (4.3.1)

To stake out constant distances.

After calling up this menu function, the following is displayed:

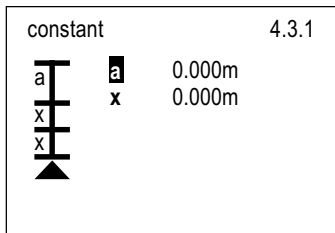

#### Entry boxes:

- a** Distance at which stake out starts.
- x** Constant distance which can be used for stake out one by one several times.

 The number of stake outs is only limited by the maximum measuring range.

The letter "a" is already displayed in black. Beside it the most recently used distance value ("x") is displayed.

-  Enter new distance "a" with the keypad, recall value from keypad memory or stack.

-  Press briefly to confirm entry.

The entered distance is displayed beside the "a".

-  Press navigation key to mark the constant "x" black.

-  Enter constant "x" with the keypad, recall value from keypad memory or stack.

The entered distance is displayed beside the "x".

-  Press briefly to change into the measurement mode and to start stake out.

Aim laser at target.

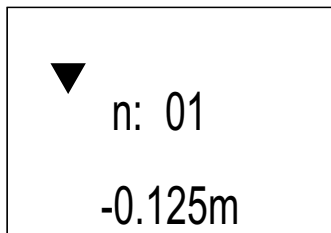

The screen displays:

- the number of the next stake out point (n),
- one or two arrows that help in the settings,
- the current distance between the reference of the DISTO and the stake out point.

Now move DISTO slowly and in a straight line towards the stake out point.

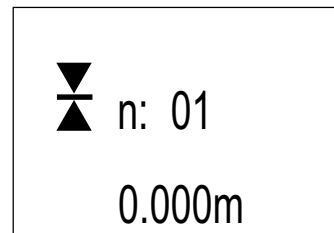

The arrow in the display points in the direction of the next stake out point. The distance displayed starts to reduce down as soon as DISTO is moved in the right direction towards the stake out point.

Once near the stake out point a short beeping sounds starts and turns into a continuous sound when the stake out point has been reached.



The exact stake out point is marked by two arrows and the distance displayed is zero.

As soon as the laser is pointed at another target, the next stake out point is displayed.

-  To terminate stake out press one of the keys briefly.
- 

DISTO changes into Normal mode and displays basic settings.

## Basic functions, contd.

 The distance between stake out points is divided into distance fields. Each stake out point lies in the middle of the respective distance field.

en

As soon as the DISTO is moved between two stake out points to a new distance field, then  
 - the number (n) in the display changes,  
 - the sign of the displayed measured value changes.

Example of a stake out:  
 Constant a ..... 1.75 m  
 Constant x ..... 1.5 m

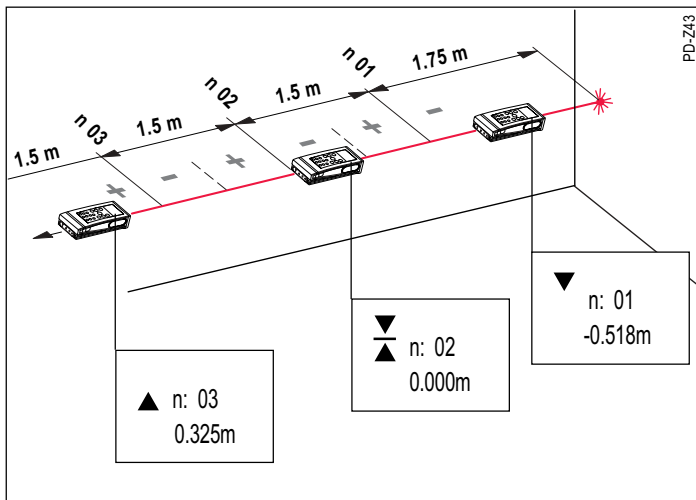

### Variable (4.3.2)

To stake out variable distances.



After calling up the menu function the following is displayed:

variable		4.3.2
1	<b>1</b>	0.000m
2	2	0.000m
3	3	0.000m

### Entry boxes:

**1-20** A maximum of 20 variable distances can be staked off one after the other.

The first variable is already marked in black on the display. Beside it the most recently used distance value is displayed.

  Enter variable distance "1" with the keypad, recall value from keypad memory or from the stack.

 Press briefly to confirm entry.

The distance entered is displayed beside the "1".

 Press navigation key to mark the "2" variable distance black.

Enter the second and all other variables as described. The first of the following no longer needed variables is to be set to "0".

 Press briefly to change into the measuring mode and start stake out.

Point laser at target.

Stake out procedures and displays of the DISTO correspond with the previously described menu function "Constants" (4.3.1).

## Basic functions, contd.

### Pythagoras (4.4)

Using this menu function distances not accessible for the DISTO can be computed indirectly.

#### Examples:

- Height and width of buildings from a distance.
- Measuring inaccessible parts of a façade.
- Comfortably measuring while standing without bending down or using accessories such as target plates.

DISTO computes the desired length by using two or three auxiliary measurements based on a right-angled triangle applying the Pythagoras function.

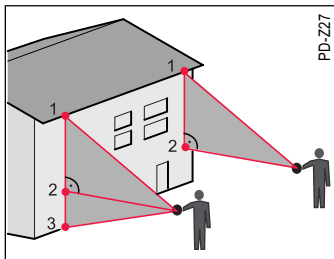

Default setting: none

The auxiliary measurements require:

- That the preset measuring directions (triangle) be adhered to.
- The laser measuring points have to be on one line in a horizontal or vertical plane. Measurements made over elevations provide wrong results.
- The second auxiliary measurement must be made perpendicular to the desired length.
- The second laser measuring point has to fall within the distance of the desired length or be the end point of that length.
- Only if measured distances are short and the DISTO can be placed firmly against an object should measurements be done holding the DISTO by hand. Exact measurements require the use of a stand.



For vertical measurement always use the stand connection on the adapter end cover of the DISTO. Only in this way does the axis of the laser beam run through the point of rotation of the stand.

If the DISTO is used with the stand connection at the bottom of the casing then the axis of the laser beam runs about 70 to 100 mm over the point of rotation. This does not matter when measuring in the horizontal, but in the vertical this can lead to considerable height deviations.

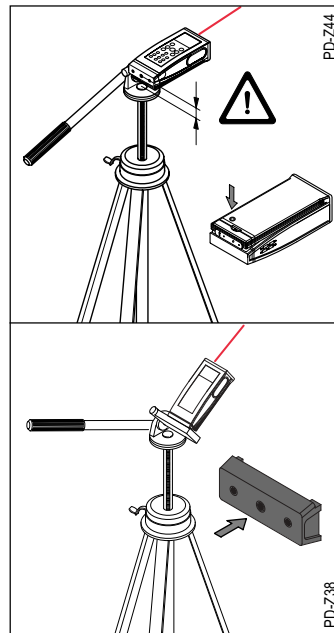

After calling up this menu function the following is displayed:

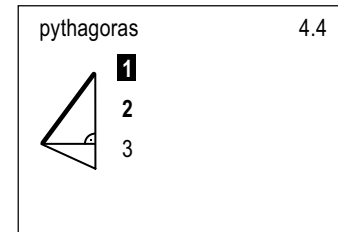

The first side of the triangle to be measured and the corresponding number "1" are displayed in black.



Press briefly to change into Pointing mode.

Point at the first measuring point with the laser.



Trigger measurement. Hold DISTO steady.



Without a stand there is the possibility of a shaky measurement. Thus in the Pointing mode either:

- use the time delay release (x-key)
- or press the trigger key long enough to start maximum tracking.

## Basic functions, contd.

Press trigger key as soon as the distance has been measured in maximum tracking mode.

 Press briefly to confirm displayed value.

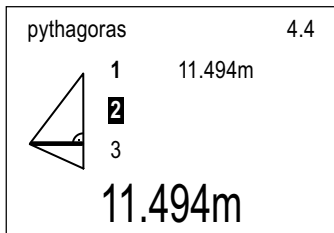



The first measured values appear beside the corresponding "1". At the same time the second side of the triangle to be measured or the height of the triangle with the corresponding number "2" is displayed in black.

Align DISTO approximately at a right angle with the reference (wall). Where the measured points were arranged vertically, it would correspond to the horizontal setting of the DISTO.

 Press briefly to change into Pointing mode.

 Press until minimum tracking starts.

 Press briefly to end minimum tracking as soon as the minimum distance has been determined.

 Press briefly to confirm displayed value.

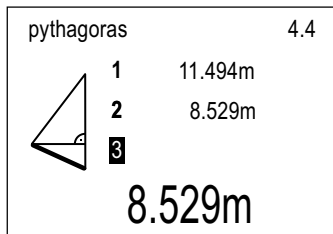

The second measured value appears beside the corresponding number "2". At the same time the last to be measured side of the triangle with the corresponding "3" is displayed in black.

 If instead of taking the third measurement, the result key is pressed, then the desired length is computed from the two measurements taken and displayed.

Otherwise take the third measurement:

 Press briefly to change into Pointing mode.

Point laser at third measured point.

 Press briefly to start measurement or hold key until minimum tracking starts.

 Press briefly to confirm the displayed value.

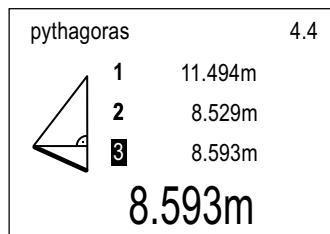

The third measured value is displayed beside the corresponding number "3".

 Each of the three measured values can be selected again with the navigation key and corrected by a new measurement.

 Press briefly to compute and display desired length.

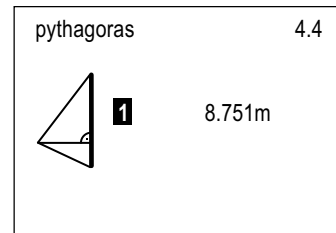

 Press briefly again to quit the menu and to display the result in basic settings..

If desired, save result to a keypad memory or to the data memory.



## Basic functions, contd.

### Height (4.5)

Using this menu function partial heights not accessible for the DISTO can be computed indirectly.

Many of the same application examples for the Pythagoras functions are valid here too.

DISTO computes the desired lengths with three auxiliary measurements using the Pythagoras function.

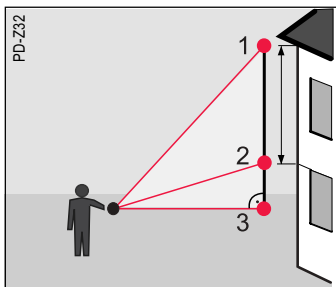

The requirements for the auxiliary measurements are the same as with the Pythagoras function, but with the following exceptions:

- The second auxiliary measured point is also the end point of the desired length.
- The third auxiliary measurement is to be made at a right angle to the desired length.

After calling up the menu function the following is displayed:

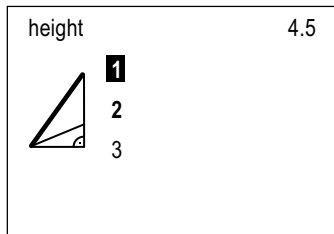

The first side of the triangle to be measured and the corresponding number "1" are displayed in black.



Press briefly to change into Pointing mode.

Point at first measuring point with the laser.



Trigger measurement. Hold DISTO steady.



Without a stand there is the possibility of a shaky measurement. Thus in the Pointing mode either:  
- use the time delay release (x-key)  
- or press the trigger key long enough to start maximum tracking.



Press briefly to confirm displayed value.

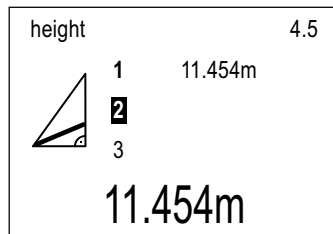

The first measured values appear beside the corresponding "1". At the same time the second side of the triangle to be measured or the height of the triangle with the corresponding number "2" is displayed in black.

Carry out the second auxiliary measurement as described previously. Pressing and holding the trigger key starts tracking.

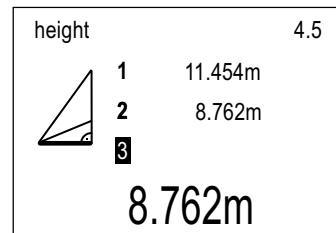

The second measured value appears beside the corresponding number "2". At the same time the last to be measured side of the triangle with the corresponding "3" is displayed in black.

Align DISTO approximately at a right angle with the reference (wall). Where the measured points were arranged vertically, it would correspond to the horizontal setting of the DISTO.



Press briefly to change into Pointing mode.



Press until minimum tracking starts.

Move laser dot up and down and crosswise along the extension of the desired measuring distance until the minimum distance can be determined.

## Basic functions, contd.

 Press briefly to end minimum tracking.

 Press briefly to confirm displayed measured value.

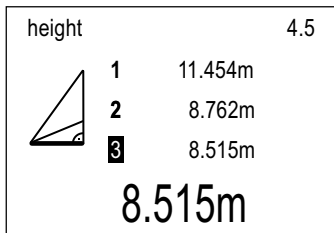

The third measured value appears beside the corresponding number "3".

 Each of the three displayed measured values can be selected again with the navigation key and corrected by a new measurement.

 Press briefly to compute and display the desired distance.

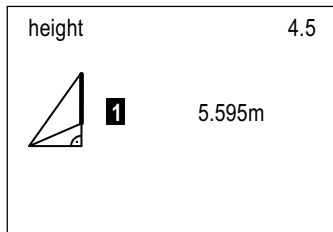

 Press briefly again to quit menu and display the result in the basic settings.

If desired save result to the keypad or data memory.

### Accuracy (4.6)

This menu function calculates the average value out of 10 sequential distance measurements.

#### Reasons for use:

- To achieve more exact results by reducing the deviation.
- To compensate for shaky measurements when DISTO is held by hand.

 Using this menu function does not improve the specified measuring accuracy of the DISTO!

 This menu function cannot be set permanently.

After calling up this menu function, the following is displayed:

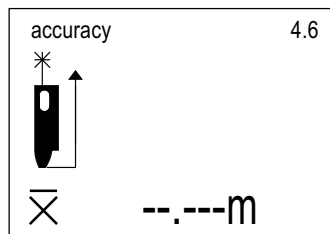



The laser lights up in the Pointing mode.

Point at target with laser.

 Press briefly to trigger measurement.

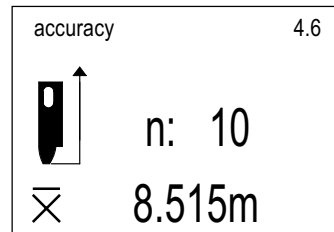
DISTO performs 10 single measurements and displays the computed average value. The laser switches off.



 Press briefly to quit menu and display average value in basic settings.

If desired, save result to the keypad or data memory.

### Average value (4.7)

 This menu function computes the average value of measurements made by the user.

It is possible to compute the average values of up to 30 measurements.

#### Application :

- Measurements made to uneven walls and ceilings.

## Basic functions, contd.

Call up menu function.

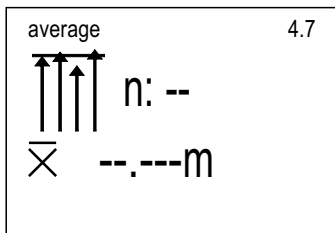

 Press briefly to start laser in Pointing mode.

Point at target with laser.

 Trigger measurement. Hold DISTO steady.

Press and hold trigger key to start tracking.

As soon as measurement is done briefly press trigger key again.

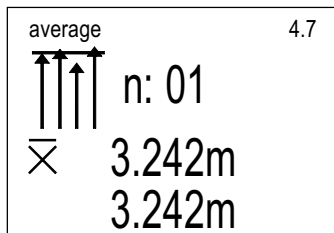



The display shows  
- n: 01 for the first measurement,  
- the calculated average value below,  
- all the way down the current value.

Carry out all other measurements as described earlier.

 Press briefly to display average value in basic settings.

If desired save result to the keypad or data memory.

## Calculation (5)

 , 4x 

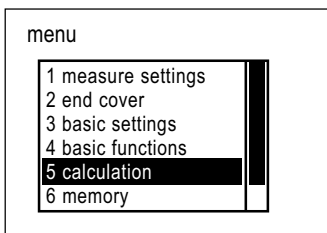



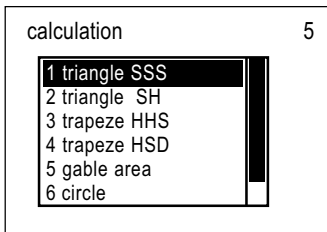

Computation of circumference, area and room volume in this menu function.

### Triangle SSS (5.1)

After measuring the three sides (SSS) of a triangle, this menu function computes  
- the height of the triangle,

- the angle opposite of the longest side of the triangle,  
- the area of the triangle.

After calling up this menu function, the following is displayed:

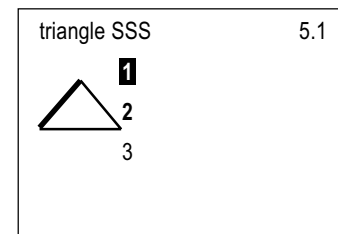

The first side to be measured and the corresponding number "1" are marked in black.

 Press briefly to change into Pointing mode.

Align DISTO and point with laser at the first point to be measured.

 Trigger measurement. Hold DISTO steady.

Press and hold the trigger key and start tracking for each side of the triangle.

en

## Calculation, contd.

As soon as the measurement is done in tracking mode, press trigger key again briefly.

 Press briefly to confirm displayed value.

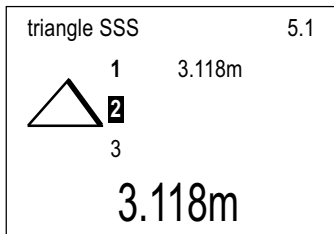

The first measured value appears beside the corresponding number "1". At the same time the second side of the triangle to be measured is marked in black with the corresponding number "2".

Measure the second and third side of the triangle as described.

 Each of the three displayed measured values can be selected again with the navigation key and corrected by a new measurement.

 After confirming the last measurement press briefly to start computation.

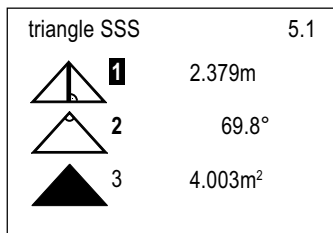

Should all results be saved to the data memory?

 Press and hold.

After saving the menu function is terminated and the basic settings are displayed.

Should only a certain result be used?

 Select desired result with navigation key.



 Press briefly to confirm selection.

Menu function is terminated and the marked result displayed in basic settings.  
If desired save result to keypad or data memory.

### Triangle SH (5.2)

After measuring the basic side and height (SH) of a triangle the menu function computes the area of the triangle.

After calling up this menu function, the following is displayed:

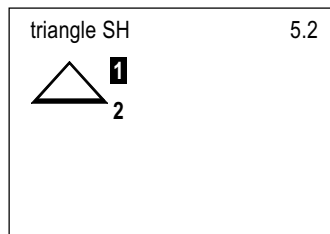

For the first measurement the base side and the corresponding number "1" are marked in black.

 Press briefly the change into Pointing mode.

Align DISTO and point with laser at the first point to be measured.

 Trigger measurement. Hold DISTO steady.

Press and hold trigger key to start minimum tracking.  
As soon as measurement is done briefly press trigger key again.

 Press briefly to confirm displayed value.

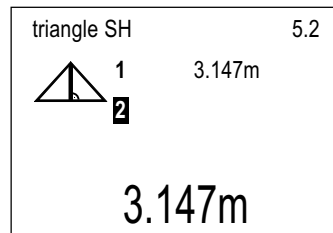

Base length is displayed beside the corresponding "1".

## Calculation, contd.

At the same time the next height to be measured is marked in black with the corresponding number "2".

Measure height of triangle as described and confirm with Enter key.

Press and hold to start maximum tracking. Press again briefly when measurement is done.

 Each of the displayed measured values can be selected with the navigation key again and corrected by a new measurement.

 After confirming the last measurement press briefly again to start computation.

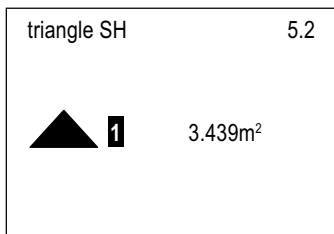

 Press again to quit menu and return to basic settings.

If desired save result to keypad or data memory.

### Trapezium HSH (5.3)

After measuring both heights and the base side (HSH) of a trapezium, this menu function computes

- the length and slope of the trapezium sides,
- the area of the trapezium.

#### Applications:

- determine roof slope.
- determine gable area of a façade with a shed roof.

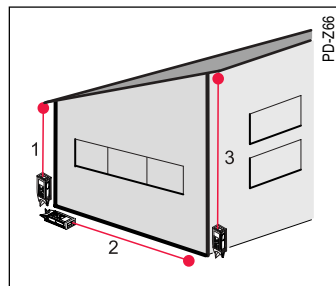

After calling up this menu function, the following is displayed:

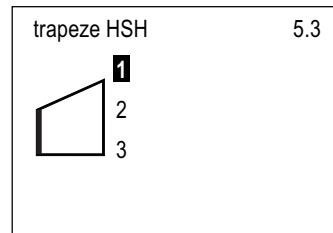

The first height to be measured (gutter height) and the corresponding number "1" are marked in black.

 Press briefly to change into Pointing mode.

Point laser at the first point to be measured.

 Trigger measurement. Hold DISTO steady.

 If there is the possibility of a shaky measurement in the Pointing mode either:

- use the time delay release (x-key)
- or press the trigger key long enough to start tracking.

 Press briefly to confirm displayed value.

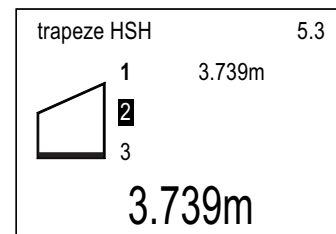

The first measured value appears beside the corresponding number "1".

At the same time the base side of the trapezium to be measured is marked in black with the corresponding number "2".

Measure the base side of the trapezium as described earlier and confirm with the Enter key.

Pressing and holding trigger key in Pointing mode starts tracking.

The second measured value appears beside the corresponding number "2".

## Calculation, contd.

The next height to be measured (roof beam height) is marked in black with number "3".



trapeze HSH		5.3
	1	3.739m
	2	2.665m
	3	

Measure roof beam height as described earlier and confirm with Enter key.

Press and hold measurement key in Pointing mode to start maximum tracking.

 Each of the displayed measured values can be selected with the navigation key again and corrected by a new measurement.

 Press briefly again to start computation after confirming last measurement.

trapeze HSH		5.3
	1	3.108m
	2	31.0°
	3	12.096m <sup>2</sup>

Should all results be saved to the data memory?

 Press and hold.

After saving, the menu function is terminated and basic settings displayed.

Should only a certain result be used?

 Select desired result with navigation keys.



 Press briefly to confirm selection.

Menu function is terminated and the marked result displayed in basic settings.

If desired save result to keypad or data memory.

### Trapezium HSD (5.4)

After measuring the height, the base length and the diagonal (HSD) of a trapezium, this menu function computes

- the length and the slope of a side of the trapezium.
- the area of the trapezium.

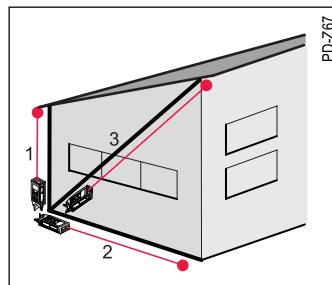

This menu function has the advantage that all measurements can be made from the same location.

After calling up the menu function, the following is displayed:

trapeze HSD		5.4
	1	
	2	
	3	

The first height to be measured (rain gutter height) and the corresponding number "1" are marked in black.

 Press briefly to change into Pointing mode.

Aim laser at the first point to be measured.

 Always measure the shorter of the two trapezium sides.

 Trigger measurement. Hold DISTO steady.

## Calculation, contd.

 If there is the possibility of a shaky measurement in the Pointing mode either:

- use the time delay release (x-key)
- or press the trigger key long enough to start tracking.

 Press briefly to confirm displayed value.

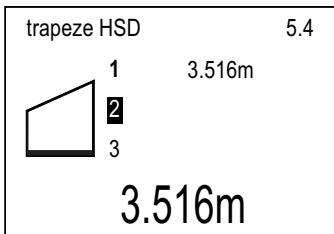

The first measured value appears beside the corresponding number "1". At the same time the base side of the trapezium to be measured is marked in black with the corresponding number "2".

Measure base length of trapezium as described earlier and confirm with Enter key.

Pressing and holding trigger key in Pointing mode starts tracking.

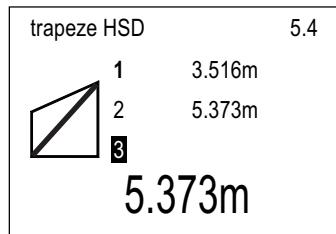

The second measured value appears beside the corresponding number "2". At the same time the diagonal to be measured next is marked in black with the corresponding number "3".

Measure diagonal of the trapezium as described earlier and confirm with Enter key.

Pressing and holding trigger key in Pointing mode starts maximum tracking.

 Each of the displayed measured values can be selected with the navigation key again and corrected by a new measurement.

 Press briefly again to start computation after confirming last measurement.

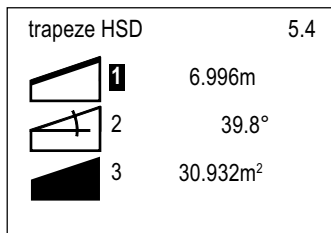

Should all results be saved to the data memory?

 Press and hold.

After saving, the menu function is terminated and basic settings displayed.

Should only a certain result be used?

 Select desired result with navigation keys.



 Press briefly to confirm selection.

Menu function is terminated and the marked result displayed in basic settings.

If desired save result to keypad or data memory.

### Gable area (5.5)

This menu function computes the gable area of a façade with symmetrical pitch roof.

#### Application:

With the gable area the modified room can be determined.

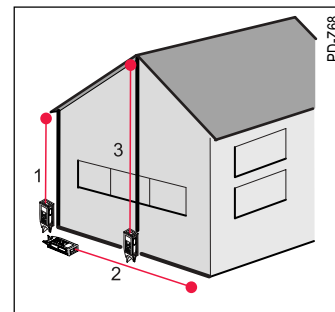

After calling up the menu function, the following is displayed:

## Calculation, contd.

en

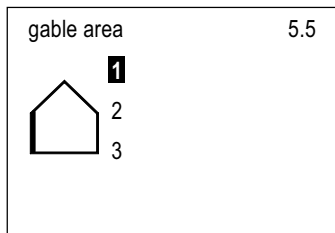

The first height to be measured (rain gutter height) and the corresponding number "1" are marked in black

 Press briefly to change into Pointing mode.

Aim laser at the first point to be measured.

 Trigger measurement. Hold DISTO steady.

 If there is the possibility of a shaky measurement in the Pointing mode either:

- use the time delay release (x-key)
- or press the trigger key long enough to start tracking.

 Press briefly to confirm displayed value.

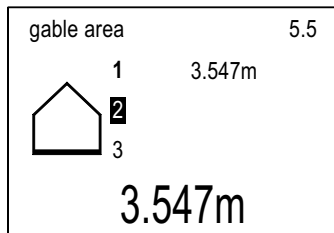

The first measured value appears beside the corresponding number "1". At the same time the next gable width to be measured is marked in black with the corresponding number "2".

Measure gable or house width as described earlier and confirm with Enter key.

Pressing and holding trigger key in Pointing mode starts tracking.

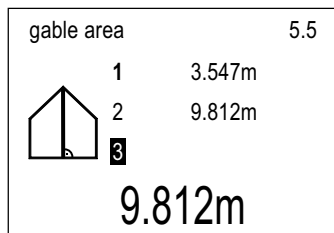

The second measured value appears beside the corresponding number "2".

At the same time the next height to be measured (roof ridge) is marked in black with the corresponding number "3".

 Press briefly to change into Pointing mode.

Aim the laser at the first bottom side.

 Trigger measurement. Hold DISTO steady.

Pressing and holding trigger key in Pointing mode starts maximum tracking.

Briefly press trigger key again when measurement is done.

 Press briefly to confirm displayed value.

 Each of the three displayed measured values can be selected with the navigation key again and corrected by a new measurement.

 After confirming the last measurement, press briefly to start computation.

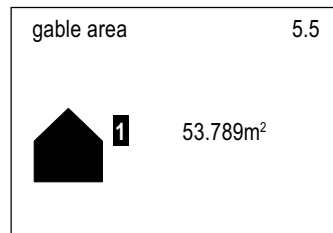

 Briefly press again to quit menu and to display the marked result in basic settings.

If desired, save result to keypad or data memory.

### **Circle (5.6)**

This menu function computes the area of a circle using the diameter.



## Calculation, contd.

### Application:

- For volumes of trees, silos, etc.
- admeasurements in pipe systems.

After calling up this menu function the following is displayed:

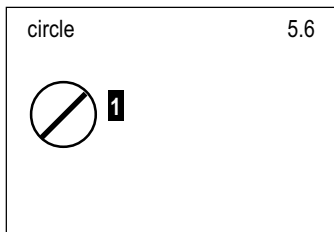

The diameter of the circle and the corresponding number "1" are marked in black.

-  Press briefly to change into Pointing mode.

Position DISTO on the circumference of the circle as reference.

Aim laser dot at a spot at the other side of the circle (e.g. ground).



Trigger measurement. Hold DISTO steady.



If there is the possibility of a shaky measurement in the Pointing mode either:  
- use the time delay release (x-key)  
- or press the trigger key long enough to start maximum tracking.

Briefly press trigger key again as soon as the measurement in maximum tracking is done.



Press twice to confirm measurement value and to start computation.

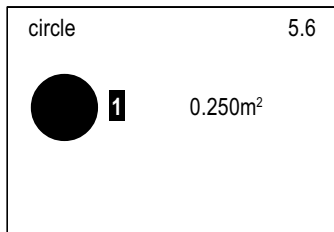

Briefly press again to quit menu and to display result in basic settings.

If desired, save result to keypad or data memory.

### Space (5.7)

This menu function computes from length, width and height of a room  
- floor and ceiling area,  
- sum of the wall areas,  
- circumference,  
- room volume.

### Application:

- Room dimensions are required by craftsmen for painting, plastering, carpeting, etc.

After calling up this menu function the following is displayed:

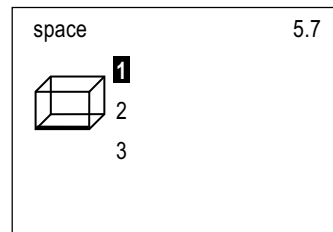

For the first measurement the room length and the corresponding number "1" are marked in black.



Press briefly to change into Pointing mode,

Align DISTO and aim with laser at the first point to be measured.



Trigger measurement. Hold DISTO steady.



If there is the possibility of a shaky measurement in the Pointing mode either:  
- use the time delay release (x-key)  
- or press the trigger key long enough to start minimum tracking.

Briefly press trigger key again as soon as the measurement in minimum tracking is done.



Press briefly to confirm displayed value.

en

## Calculation, contd.

space 5.7

1 4.563m

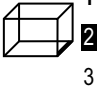

2

3

4.563m

The room length is displayed beside the corresponding number "1". At the same time the next width to be measured is marked in black with the corresponding number "2".

Measure width of the room as described earlier and confirm with Enter key. Then measure room height (no. 3) and confirm.

 Press again briefly to start computation.

The results of the computations are explained with graphics and are numbered in sequence (1-4):

1 ..... ceiling / floor area  
 2 ..... surface area  
 3 ..... circumference  
 4 ..... volume

space 5.7

 1 26.369m<sup>2</sup>

 2 82.632m<sup>2</sup>

 3 20.684m

 4 105.344m<sup>3</sup>

Should all results be saved to data memory?

 Press and hold.

After saving, the menu function is terminated and basic settings displayed.

Should only a certain result be used?

 Select desired result with navigation keys.





 Press briefly to confirm selection.

Menu function is terminated and the marked result displayed in basic settings.

If desired save result to keypad or data memory.

## Memory (6)

 , 5x 

menu

1 measure settings  
 2 end cover  
 3 basic settings  
 4 basic functions  
 5 calculation  
 6 memory



memory 6

1 memory key 1-9  
 2 recall key 1-9  
 3 stack  
 4 data

DISTO has many ways of saving measurements and computations.

The last displayed measurement, computation or entry is saved when DISTO is switched off and appears in the basic settings when DISTO is switched on again.

## Memory key 1 - 9 (6.1)

Nine memory places are allocated with various in and output possibilities to save intermediate results or often used data (addition, subtraction, pivot gap, etc.).

The menu function only serves to save data. Calling up saved data is done with the menu function "recall key 1 - 9" (6.2).

Default setting: After reset all memory keys (3.4) are deleted.

### Precondition:

Before saving the respective measured or computed value must be displayed in basic setting. Entries via keypad must be confirmed with the Enter key.

### Saving with menu

After calling up this menu function the following is displayed:

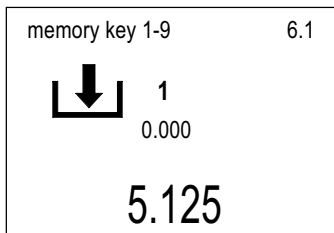

The arrow in the symbol means saving; the number beside it the allocated memory key (1-9).

Below in small fonts the current memory contents is displayed or "0.000" if the memory key has not been allocated. The current memory content is overwritten when new data is saved in that memory key.

- Select a (free) memory key with the navigation keys or by directly entering the memory key number.
- Press briefly to save.

After a short confirmation, basic setting are displayed.

### Saving with short cut

Press briefly to call up main menu.

. + ... +

Enter short cut for "memory key" (6.1) and add the number of the desired memory allocation (1 - 9) .

After confirmation of saving the basic settings are displayed.

### Saving with memory key

Data is allocated to each memory key from 1 to 9.

Press and hold desired key, e.g. key 3 for memory key 3 .

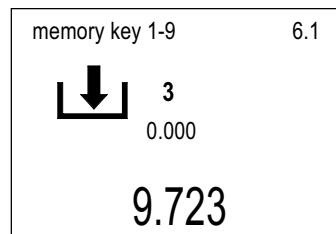

The corresponding memory key is displayed.

Press briefly to save.

After a short confirmation the basic settings are displayed.

### Recall key 1-9 (6.2)

This menu function only serves to recall one of the nine memory keys. Saving data in a memory key is done in the menu function "Memory key 1-9" (6.1).

When called up, the value in the basic settings is replaced by the contents of a memory key.

### Recall with menu

After calling up the menu function, the following is displayed:

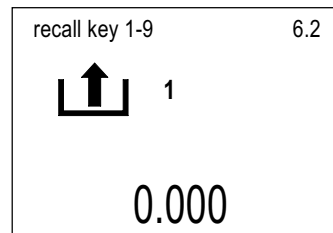

The arrow in the symbol means recalling; the number beside it the allocated memory key (1 - 9).

Below the current memory contents is displayed or "0.000", if the memory key is not being used.

- Select memory key with navigation keys or select directly via keypad entry.
- Press briefly to recall contents.

After a short confirmation the contents appear in basic settings.

### Recall with short cut

Press briefly to call up main menu.

. + ... +

Enter short cut for menu function "recall key 1-9" (6.2) and add the number of the desired memory location (1 - 9).

## Memory, contd.

After saving a short confirmation appears, then the basic settings.

### Recall with 0 key

 Press until there is an audible beep (approx. 1 sec).

 If the key is pressed for too long the stack contents is displayed (6.3).

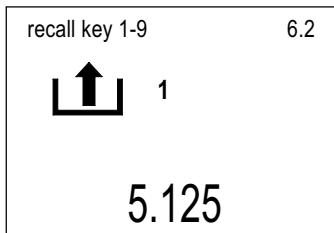

The first memory key is displayed.

 Select memory key with navigation keys or select directly via keypad entry



 Press briefly to display contents.

After a short confirmation, basic settings are displayed.

### Stack (6.3)

The stack saves the last 15 measurements, computations or entries automatically to a shift register. This means the saved values have no fixed allocation but "shift" through the stack.

When all 15 memory locations in the stack are occupied, each new entry will delete /overwrite the most recent memory location used.

Default setting: after reset the stack is deleted (3.4)

### Recall with menu

After calling up the menu function, the following is displayed:

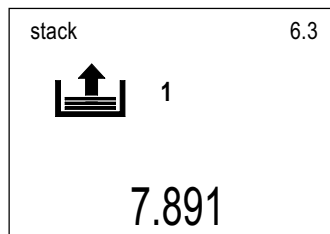



The arrow stands for recalling the stack; the number beside it shows the memory location in the stack (1-15).

Below the current memory contents is shown or "0.000" if the memory location in the stack is empty.

The most recent (current) entry is always in memory location 1, the second to last entry in memory location 2, etc.

 Select memory key with navigation keys or select directly via keypad entry.





 Press briefly to recall contents.

After a short confirmation the memory contents is displayed in basic settings.

 The results of individual measurements for basic functions (Pythagoras, heights) or computations (triangles, trapeziums, etc.) can be recalled from the stack and used for further calculations.

### Recall with 0 key

 Press and hold key for about 2 seconds until two beep sounds are audible.

 If the key is pressed for too short a period then the memory key is displayed (6.2).

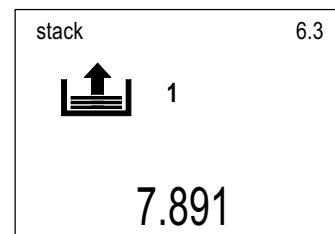

## Memory, contd.

The first memory location of the stack is displayed.

 Select desired memory location with the navigation keys or by direct keypad entry.

 Press briefly to call up content.

After a short confirmation, the memory content is displayed in basic settings.

### Data (6.4)

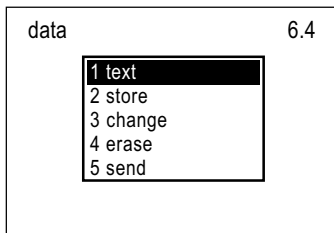

This submenu manages data memory.

Default settings: none, meaning that a reset (3.4) does **not delete** the data memory.

### Text (6.4.1)

This menu function is used to enter text in the data memory, e.g. to document measurements.



After calling up this menu function the next free memory location is displayed.

Using the keypad, a text of maximum 30 characters can be entered.

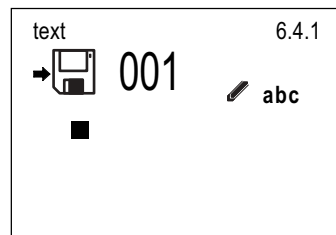
The text is displayed in three lines, but transmitted as one line via the data interface.





 Press briefly to change between small and capital letters.

  
⋮  
 Repeatedly press corresponding key to call up the desired special character. (described in section "Keypad" under "Text and data input").

 Wait with next input until the cursor has moved a position further.

 Press briefly for "space". Press and hold to enter the number "0".

 Press briefly, to move back one space and overwrite the last entry. Repeat above process to delete entries step by step.

 Press briefly to end and save text input.

After a confirmation, the basic settings are displayed.

The menu function Send (6.4.5), enables the saved data to be transmitted to a PC and displayed in an Excel sheet.

### Store (6.4.2)

Menu function to store measured and computed values into the data memory.

### Store with menu

Precondition: The value to be stored is displayed in basic settings.

After calling up the menu function, the next free memory location is displayed.

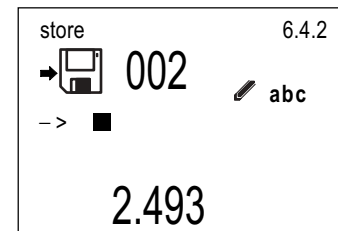



Additionally, a three line text with a maximum length of 8 characters per line, can be entered using the keypad.

## Memory, contd.

 By clearly describing stored values, misunderstandings and questions can be avoided.

Enter text as described in menu function (6.4.1).

-  Press briefly to move cursor to next text line.
-  Press briefly to end and store input.



After a confirmation basic settings are displayed.

As an alternative text input can be made from a predefined list.

Precondition: The list was loaded into DISTO previously (read Online documentation on supplied CD-ROM).

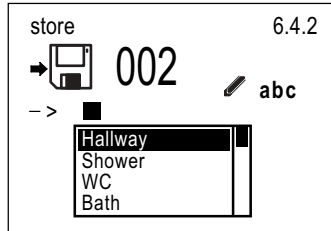
-  Press briefly to display the list of the predefined texts.



-  Select desired entry from list.
-  Press briefly to confirm entry.

Follow same procedure to input subsequent entries from the list.

-  Press briefly to end and store text entries.

After a short confirmation the basic setting are displayed.

 In storing a new value, the DISTO automatically uses the first two text lines of the last memory location.

### Storing with Enter key

When a value displayed in the basic setting is to be stored:

-  Press and hold.

The display shows

- the next free memory location,
- a cursor to enter text.

If desired, enter text as described earlier.

-  Press briefly to store.

After a confirmation the basic settings are displayed.

If all results of a calculation are to be stored (e.g. pythagoras, triangles, heights, ...) in the data memory:

-  Press and hold immediately after computed results are displayed.

The display shows

- the next free memory location,
- a cursor to enter text.

If desired, enter text in the first line as described earlier.

 This text is automatically used for the next following results.

The two other lines

- are reserved for text input,
- contain text predefined by the calculation function.

-  Press briefly to store results one after the other.

After a confirmation the basic settings are displayed.

### Change (6.4.3)

With this menu function, data stored to memory can be changed subsequently.

After calling up the menu function, the menu displays

- the last stored value,
- the number of the memory location,
- the amount of occupied memory locations and the occupancy of memory in percentage.

## Memory, contd.

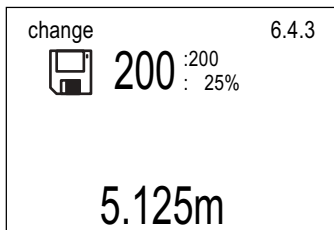

- Select desired memory location with navigation keys or by keypad input.

If desired the selected memory location can be reserved to transmit data to a PC.

- Press briefly to reserve memory location.
- This symbol is displayed. Memory location and contents remain unchanged.

Press Clear key again to free up the memory location for data transfer .

- Press briefly to start making changes.

- Place cursor with the navigation keys on the line to be changed.
- 

- To delete press briefly.

Enter new text or value with keypad or recall it from the memory keys or from the stack.

- Press and hold as desired.

- To add a measurement unit press (repeatedly).

- A line of text can be replaced by a list. Read menu function Store (6.4.2).

- Press briefly to store changes.

After a confirmation the basic settings are displayed.

### Erase (6.4.4)

This menu function erases the entire data memory.

After calling up this menu function, a request is displayed.



Cancel menu function?

- Press briefly to display the submenu "data" (6.4) or press and hold to display the basic settings.

Erase ?

- Press briefly.

After erasing the data memory a confirmation is displayed and then the basic settings.

### Send (6.4.5)

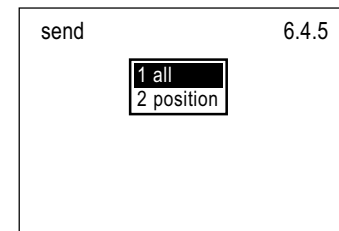

This submenu transmits the contents of the data memory via the data interface to a PC or a laptop.

#### All (6.4.5.1)

This menu function transmits the entire data memory contents.

During transmission, the number of the current data memory location being transmitted from is displayed.

At the end of the transmission the submenu is displayed again.

#### Position (6.4.5.2)

This menu function transmits certain locations of the data memory.

## Memory, contd.

After calling up this menu function, the following is displayed:

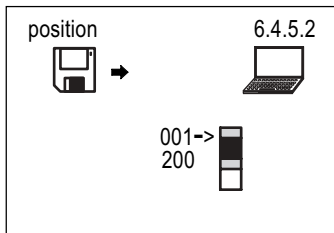

The vertical bar shows memory location from the first to the last location.

Selecting memory locations for data transmission :

- Place arrow on the first or last memory location.
- Enter the first and the last memory location and then one after the other the selected memory location numbers of the memory area.
- Press briefly to confirm selection and to start data transfer.

During transmission, the number of the current data memory location being transmitted from is displayed.

At the end of the transmission the submenu is displayed again.

### Calculator (7)

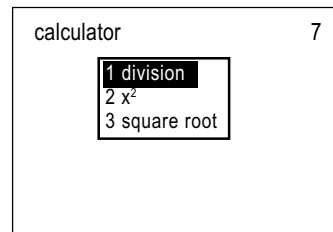
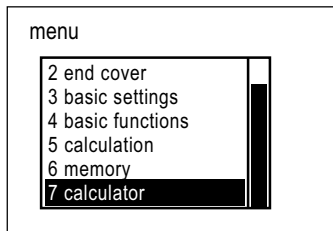
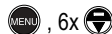

The calculation functions in this submenu supplement the four fundamental rules of arithmetics as described in section "Simple calculations".



If the wrong measuring units are used the following error message appears:

- Area and volume dimensions cannot be squared.
- From lengths or volume dimensions no square roots can be calculated, etc.

### Division (7.1)

Precondition: The first value to be calculated with has to appear in the basic settings.

Each entry with the keypad has to be confirmed with the Enter key.

After calling up the menu function the following is displayed:

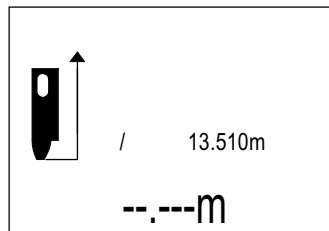

The first value to be calculated with is displayed in small font size.

- The second number may be
- entered with the keypad,
  - recalled from memory key or from the stack,
  - determined by a distance measurement.



Press briefly to compute.

The result is displayed in the basic settings.

### x<sup>2</sup> (7.2)

Precondition: The first value to be computed with has to appear in the basic settings.

After calling up the menu function the computation is performed immediately and the result displayed in the basic settings.

### Square root (7.3)

Precondition: The first value to be computed with has to appear in the basic settings.

After calling up the menu function the computation is performed immediately and the result displayed in the basic settings.



## User Information

### Range

In daylight (outdoors) always work with a laser viewfinder. If necessary, shade the target area.

#### Increased ranges:

At night, at dusk and when target area is in the shade.

#### Reduced range:

The range of the DISTO can be reduced by matt, green and blue surfaces (also by trees or plants).

### Rough surfaces

Rough surfaces (e.g. coarse plaster) a mean value is indicated.

To avoid measuring to the bottom of plaster joints: Use target plate, 3M "Post-it" or board.

### Transparent surfaces

To avoid measuring errors, do not measure towards colorless liquids (like water) or (dust free) glass. For materials and liquids unfamiliar to you always take a trial measurement.

 When aiming through panes of glass, or if there are several objects in the line of sight, erroneous measurements can occur.

### Wet, smooth and high-gloss surfaces

1. Aiming at a "flat" angle deflects the laser beam. The DISTO may receive a signal that is too weak (error message 255).
2. Aiming at a right angle, the DISTO may receive a signal that is too strong (error message 256).

### Inclined, round surfaces

Can be measured with the laser. Requirement: There is enough area on the target surface for the laser spot.

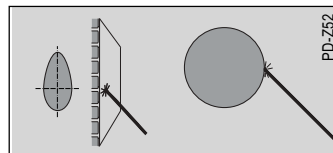

### Free- handed aiming

(approx. 20 - 40 m):  
Use target plate 563875 (DIN C6) resp. 723385 (DIN A4) or:  
**Make your own target plates of any size:**

Distance	Order
up to 30 m (white)	Scotch Cal*
30 - 100 m (brown)	Engineering-Grade 3279 (7502 99 61 036)*

\* Manufacturer: 3MCompany

### Measuring in the field

Attach the telescopic viewfinder, and check it is engaged by applying pressure from the side.

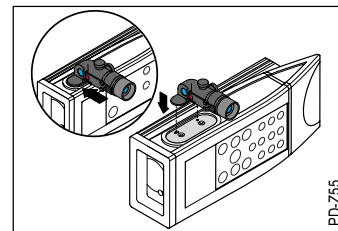

### Setting viewfinder

1. With menu function "permanent" (1.4.2) place DISTO in Continuous mode.
2. Place indoors 5 m, 10 m or 30 m from the wall.
3. Attach alignment aid for telescopic viewfinders to the wall as in illustration below.

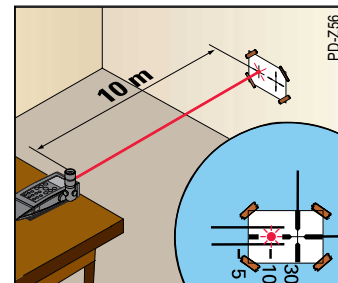

## Measuring in the field, contd.

Please copy diagram below (1:1).

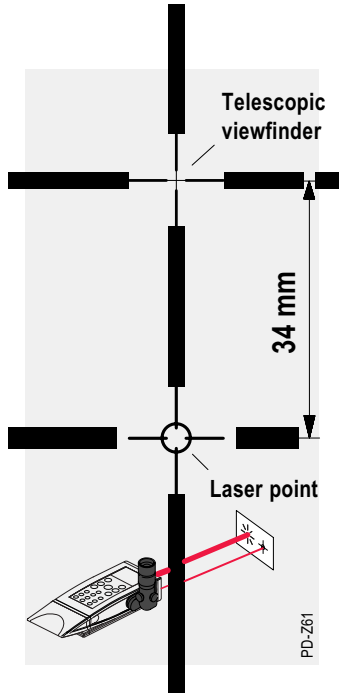

4. Focus cross hairs and laser dot by slowly turning the eyepiece adjustment screws.

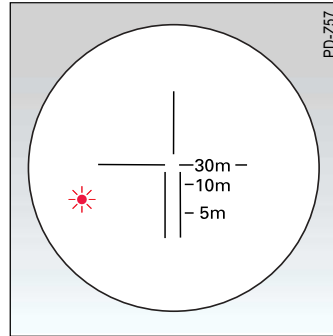

5. Align the telescopic viewfinder with the laser point (side, height)

Example: Positioned exactly 5m in front of a wall ( $\pm 0.5$  m), center the laser dot beside the 5 m distance mark.

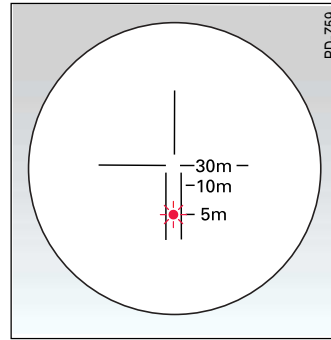

In the field, check adjustment from time to time (in semi shaded area approx. 10 - 15 m). Aim with or without red filter (increases visibility).

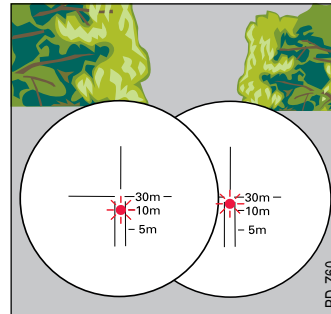

## Accessories

### Accessories for measurements

#### Telescopic viewfinder (667478)

For easier aiming in the field. For highly accurate aiming while far away from the object (four-fold magnification). Carry in holster attachable to belt.

#### Laser dot glasses (723777)

Red filter glasses for improved visibility in bright rooms or in the field up to distances of approx. 10 - 12 m.

#### Target plate 563875 (DIN C6)

#### Target plate 723385 (DIN A4)

For poorly reflecting surfaces use; white side for up to 40 - 50 m. Beyond this distance, brown side with the special reflection layer.

#### Target plate (723774)

For handy work indoors. Target plate can be pinned or glued on.

Target plate sizes:

73 x 98 mm / 147 x 98 mm

#### Bubble level (667158)

For horizontal and vertical aiming, e.g. when floor and walls are very uneven.

## Accessories, contd.

Aiming accuracy is approx.  $1^\circ$  corresponding to a measuring error of only about 5 mm at a distance of 30 m.



DISTO with this level is not a laser level!

### Short brackets (723775)

50 mm long; for U-shaped rails for shutters.

### Long brackets (723776)

150 mm long; for measuring from open windows.

### Stand adapter (725286)

For correct measurements (Pythagoras, height) using any camera stand. DISTO rotates around a defined geometrical point.



As stand, we recommend the **SLIK U9000**:

- wide swivelling range.
- no stand adapter required.

## Accessories for data interface

### Data cable GEV102-1 (725078)

To connect to a PC or laptop. (2 m cable with Lemo-plug, size 0 and 9 pole D-plug with socket contact).

### Data cable (708175)

To connect to a palmtop with a standard cable (30 cm long cable with cable with Lemo-plug, size 0 and 9 pole D-plug with pin contact).



To connect PC's, laptops, etc., a commercially available zero modem cable is required.

## Transport accessories

### Carrying pouch (667169)

Large black carrying pouch for transportation and protection. Compartments for user manual, telescopic viewfinder and palmtop computer.

### Holster (667489)

For max. protection. Fitted to belt.

### Wrist strap (667491)

With fastening thread to prevent instrument from dropping to the ground while in use.

### Shoulder strap (563879)

Adjustable with fastening thread.

### DISTO-Clip (714871)

To carry the instrument on your body with special screw.

## Safety Instructions

The following directions should enable the person responsible for the DISTO, and the person who actually uses the instrument, to anticipate and avoid operational hazards. The person responsible for the instrument must ensure that all users understand these directions and adhere to them.

## Use of the Instrument

### Permitted use

The permitted uses of the DISTO are the following:

- Measuring distances
- Computing using menu functions
- Storing measurements

### Prohibited uses

- Using the instrument without instruction
- Using outside the stated limits
- Deactivation of safety systems and removal of explanatory and hazard labels
- Opening of the equipment by using tools (screwdrivers etc.), as far as not specifically permitted for certain cases.

- Carrying out modification or conversion of the product
- Use after misappropriation
- Use of accessories from other manufacturers without the express approval of Leica Geosystems
- Deliberate or irresponsible behaviour on scaffolding, when using ladders, when measuring near machines which are running, or near parts of machines or installations which are unprotected
- Aiming directly into the sun
- Deliberate dazzling of third parties; also in the dark
- Insufficient safety measures taken at the site of work (e.g.: taking measurements on streets, etc.)



### WARNING:

Prohibited use can lead to injury, malfunction, and material damage. It is the task of the person responsible for the instrument to inform the user about hazards and how to counteract them.

The DISTO is not to be operated until the user has been instructed.

en

## Limits to use

 See "Technical Data"

### Environment:

Suitable for use in an atmosphere appropriate for permanent human habitation. Cannot be used in an aggressive or explosive environment. Use in rain is permissible for limited periods.

## Areas of Responsibility

### Responsibilities of the manufacturer of the original equipment Leica Geosystems AG, CH-9435 Heerbrugg (Leica Geosystems):

Leica Geosystems is responsible for supplying the product, including the user manual and original accessories, in a completely safe condition.

### Responsibilities of the manufacturer of non-Leica accessories:

 The manufacturers of non-Leica Geosystems accessories for the DISTO are responsible for developing, implementing and communicating safety concepts for their products. They are also responsible for the effectiveness of these safety concepts in combination with the Leica Geosystems equipment.

### Responsibilities of the person in charge of the instrument:

 **WARNING:** The person responsible for the instrument must ensure that the equipment is used in accordance with the instructions. This person is also accountable for the deployment of personnel and for their training and for the safety of the equipment when in use.

The person in charge of the instrument has the following duties:

- To understand the safety instructions on the product and the instructions in the User Manual.
- To be familiar with local safety regulations relating to accident prevention.
- To inform Leica Geosystems immediately if the equipment becomes unsafe.

## Hazards in Use

### Important hazards in use

 **WARNING:** The absence of instruction, or the inadequate imparting of instruction, can lead to incorrect or prohibited use, and can give rise to

accidents with far-reaching human, material, financial and environmental consequences.

### Precautions:

All users must follow the safety instructions given by the manufacturer and the directions of the person responsible for the instrument.

 **CAUTION:**

Watch out for erroneous distance measurements if the instrument is defective or if it has been dropped or has been misused or modified (e.g. changing the end cover).

### Precautions:

Carry out periodic test measurements. Particularly after the instrument has been subject to abnormal use, before, during and after important measurements and after changing end covers. Keep optical lenses clean and check for mechanical damage to the DISTO.

 **CAUTION:**

Take care when aiming the DISTO directly into the sun. The receiver lens acts as a magnifying glass and can thus cause damage to the instrument internals.

### Precautions:

Do not aim the DISTO directly at the sun

 **WARNING:**

Insufficient securing or marking of your measurement site could cause a dangerous situation on the public highway, building site, or in the factory etc.

### Precautions:

Always ensure your measurement site is appropriately secured. Obey the local accident prevention regulations, and road safety rules, at all times.

 **CAUTION:**

In using the instrument to measure distances or moving objects (e.g. cranes, building machines, platforms, ...) unforeseen events can lead to errors in measuring.

### Precautions:

Only use this instrument as a measuring sensor and not as a control unit.

## Hazards in Use, contd.

Your system has to be designed and operated in such a way, that it is secured (e.g. terminal safety switch) against damage due to error in measurements, defects on the instrument or power interruptions.

 **CAUTION:** Strong magnetic fields in the measuring environment can influence automatic end cover recognition and lead to errors while measuring.

**Precautions:**  
When measuring near magnetic fields (e.g. magnets, transformer stations,...) DISTO automatic end cover recognition should be monitored or switched off.

 **WARNING:** If the product is used together with computers which have not been approved by the manufacturer for use in the field, there is a danger of electric shock.

**Precautions:**  
Follow the directions given by the manufacturer for using computer equipment in the field with our systems.

 **CAUTION:** On sending the instrument, or on the disposal of batteries that are not fully discharged, a fire could be caused by improper treatment.

**Precautions:**  
Remove the batteries from their compartment before sending the instrument. Dispose of batteries only if they are completely discharged (operate the instrument in tracking mode, until batteries are completely discharged).

 **CAUTION:** If you do not intend using the instrument for a long time, the batteries may leak and damage the equipment!

**Precautions:**  
Remove batteries if you are not going to use the instrument for an extended period.

 **CAUTION:** Safety measures could be voided, persons hurt if the instrument is not used as intended e.g. it could be damaged mechanically (e.g. being dropped, tossed against other objects...) or damaged by improperly installing add-ons and attachments.

**Precautions:**  
Make sure accessories (e.g. telescopic viewfinders, hand loops, shoulder straps ...) are properly attached and locked in place. Protect your instrument from mechanical damage.

 **CAUTION:** If the equipment is improperly disposed of, the following can happen:

- If plastic parts are burnt, poisonous gases are produced which may impair health.
- If batteries are damaged or overheated, they can explode and cause poisoning, burning, corrosion or environmental contamination.
- By disposing of the equipment irresponsibly you may enable unauthorized persons to use it in contravention of the regulations, exposing themselves and third parties to the risk of severe injury and contaminating the environment.

**Precautions:**  
Dispose of the equipment appropriately in accordance with the regulations in force in your country. Always prevent access to the equipment by unauthorized personnel.

## Laser Classification

The DISTO produces a visible laser beam which emerges from the front of the instrument. It is a Class 2 laser product in accordance with:

- IEC60825-1: 1993 "Radiation safety of laser products"
- EN60825-1: 1994 "Radiation safety of laser products"

It is a Class II laser product in accordance with:

- FDA 21CFR Ch.I §1040: 1988 (US Department of Health and Human Service, Code of Federal Regulations)

## Laser Classification, contd.

Laser Class 2/III products:  
Do not stare into the laser beam or direct it towards other people unnecessarily. Eye protection is normally afforded by aversion responses including the blink reflex.

en

**WARNING:**  
Looking directly into the beam with optical aids (e.g. binoculars, telescopes) can be hazardous.  
**Precautions:**  
Do not look directly into the beam with optical aids.

**CAUTION:**  
Looking directly into the laser can be hazardous to the eye.  
**Precautions:**  
Do not look into the laser beam. Make sure the laser beam is aimed below or above eye level (especially with fixed installations, machines, etc.).

### Labelling

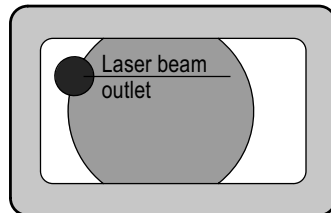
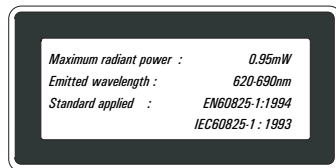

PD-Z47

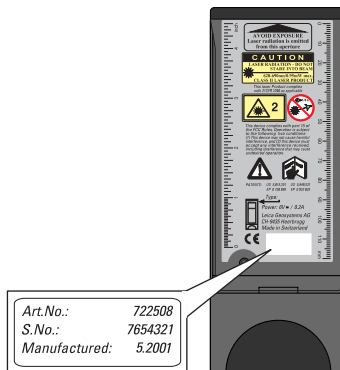

Beam divergence	0.16 x 0.6 mrad
Pulse duration	15 x 10 <sup>-9</sup> s
Maximum radiant power	0.95 mW
Maximum radiant power per pulse	8 mW
Measurement uncertainty	±5%

**CAUTION:**  
Allow only authorized Leica Geosystems service workshops to service the instruments.

### DISTO with Telescopic Viewfinder

**WARNING:**  
Looking right at the reflected laser beam in a DISTO operated with telescopic viewfinder could be dangerous when you aim at areas that reflect like a mirror, or emit reflections unexpectedly (e.g. a mirror, metallic surfaces, windows, prisms, liquids).  
**Precautions:**  
If you using a telescopic viewfinder, do not aim at areas that are reflective like a mirror, or which could produce unintended reflections (e.g. mirrors, metallic surfaces, windows, prisms).

### Electromagnetic Compatibility (EMC)

The term "electromagnetic compatibility" is taken to mean the capability of the DISTO to function smoothly in an environment where electromagnetic radiation and electrostatic discharges are present, and without causing electromagnetic interference to other equipment.

**WARNING:**  
Electromagnetic radiation can cause interference in other equipment. Although the DISTO meets the strict regulations and standards which are in force in this respect, Leica Geosystems cannot completely exclude the possibility that interference may be caused to other equipment.

**CAUTION:**  
Interference can be caused in other equipment if DISTO is used in combination with third party devices (e.g. field computer, PC, various cables...).

## Electromagnetic Compatibility (EMC), contd.

### Precautions:

Only use equipment or accessories recommended by Leica. They fulfill the stringent requirements and norms in combination with DISTO. Keep in mind the computer manufacturer specifications on EMC.

### CAUTION:

Interference caused by electromagnetic radiation can result in the tolerance limits for measurements being exceeded. Although the DISTO meets the strict regulations and standards which are in force in this respect, Leica Geosystems cannot completely exclude the possibility that interference may be caused to the DISTO by very intensive electromagnetic radiation, for instance near radio transmitters, walkie-talkies, diesel generators etc. Under such conditions, check measurement results for their plausibility.

### WARNING:

Operating DISTO with one end of a cable connected (e.g. external feeder cable, interface cable,...) can lead to exceeding the electro-magnetic emission of radiation and thereby causing interference in other instruments.

### Precautions:

While operating the DISTO, cables must be connected at both ends (e.g. instrument/computer,...).

### FCC Statement (applic. in U.S.)

### WARNING:

This equipment has been tested and found to comply with the limits for a Class B digital device, pursuant to part 15 of the FCC Rules.. These limits are designed to provide reasonable protection against harmful interference in a residential installation. Instruments of this kind generate high frequency and may radiate them, too.

If not installed and used in accordance with the instructions, they may cause harmful interference to radio communications.

However, there is no guarantee that interference will not occur in a particular installation.

If this equipment does cause harmful interference to radio or television reception, which can be determined by turning the equipment off and on, the user is encouraged to try to correct the interference by one or more of the following measures:

- Reorient or relocate the receiving antenna.
- Increase the separation between the equipment and receiver.
- Connect the equipment into an outlet on a circuit different from that to which the receiver is connected.
- Consult the dealer or an experienced radio/TV technician for help.

### WARNING:

Changes or modifications not expressly approved by Leica Geosystems for compliance could void the user's authority to operate the equipment.

### Product labelling:

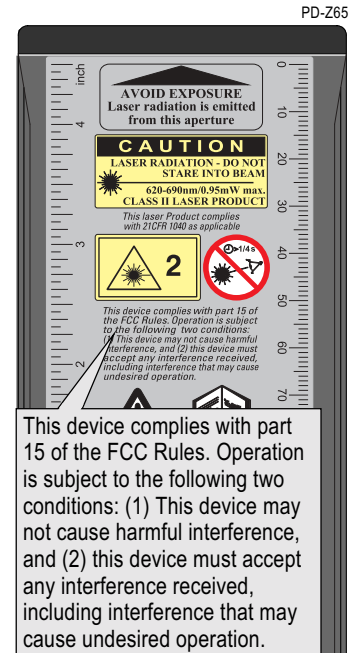

### Care

#### Clean and dry

- Blow away dust from lenses.
- Do not touch glass with fingers.
- Only clean with a soft cloth; if necessary, damp with pure alcohol. Do not use other cleaning agents. Plastic parts could be affected.

Wipe off splashes of cement, plaster etc. as quickly as possible, using water and a damp cloth or sponge. Look after the optical surfaces with the same care that you would apply to spectacles, cameras and field glasses.

### Storage

 Please respect the temperature limits, specially during summer when storing the equipment inside a vehicle (-40°C to +70°C / -40°F to +158°F).

 Unpack instruments and accessories that have become wet. Dry off the instrument, container and accessories (at maximum 40 °C / 108 °F) and clean. Only repack the equipment when it is completely dry.

 After longer periods of storage or transport carry out a check measurement before using the equipment.

If the indoor and outdoor temperatures are very different, allow time for the instrument to adapt

If the DISTO is removed from an air-conditioned room and exposed to warm damp air, the instrument and the optics will fog over. To reduce this effect, cover the instrument with a cloth and allow it to adapt slowly to the new conditions as you would for a camera or a video.

### Transport

The Leica Geosystems holster protects the DISTO well against mechanical shock, but not against water or dust.

It is recommended that you always transport the DISTO in the Leica Geosystems holster or an equivalent protective container or packaging.

Pack the end cover into the holster as shown below.

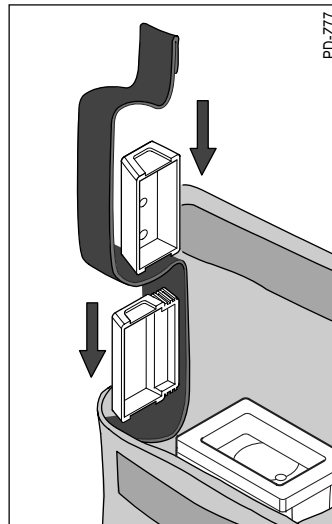

Do not exceed temperature limits.

Please ask if you may take DISTO as hand luggage when travelling by air.

### Despatch

 Always use the original Leica Geosystems packaging (holster and shipment box) for sending the instrument. You must remove the batteries (send the instrument **without** batteries).



## Technical Data

	DISTO pro <sup>4</sup>	DISTO pro <sup>4</sup> a
Measuring accuracy	typical.: ± 3 mm / max.: ± 5 mm *	typical.: ± 1.5 mm / max.: ± 2 mm *
Smallest displayed unit	1 mm	1 mm
Range	0.3 m to over 100 m **	0.3 m to over 100 m **
Time for a measurement ,distance	0.5 ... approx.4 s	0.5 ...approx.4 s
Time for a measurement, tracking	0.16 ...approx.1 s	0.16 ... approx.1 s
Battery capacity (4 x 1,5V, AAA type)	over 3000 measurements	over 3000 measurements
Laser	visibility; 635 nm	visibility; 635 nm
Ø Laser dot (at distance)	6 / 30 / 60 mm (10 / 50 / 100 m)	6 / 30 / 60 mm (10 / 50 / 100 m)
Measuring in the field (adaptor for telescopic viewfinder)	✓	✓
Distance measurement	✓	✓
Timer	✓	✓
Tracking (continuous measurement)	✓	✓
Minimum/maximum distance-tracking	✓	✓
Calculation function (Pythagoras, areas, angles, ...)	14	14
Pocket calculator	✓	✓
Data memory	800 measured values	800 measured values
Memory key for constant values	9 constants	9 constants
Stack (buffer)	15 last values	15 last values
Graphic display, four lines, with LED	✓	✓
Alpha numeric keypad	✓	✓
Data interface	✓	✓
End cover with swivel foot	✓	✓
End cover with positioning bracket and alignment aid	✓	✓
Adapter end cover	✓	✓
Dust and splash proof	IP54 acc. IEC60529: rain proof,dust protected	IP54 acc. IEC60529:rain proof,dust protected
Dimensions, weight	188 x 70 x 47 mm, 440 g	188 x 70 x 47 mm, 440 g
Temperature range	-40°C to +70°C (-40°F to +158°F) -10°C to +50°C (-14°F to +122°F)	-40°C to +70°C (-40°F to +158°F) -10°C to +50°C (-14°F to +122°F)
storage operations		

en

## Remarks on Measuring Accuracy

 Both references (\*, \*\*) relate to the technical data on the previous page.

\*The measuring accuracy corresponds to the ISO-recommendation ISO/R 1938-1971 with a statistical confidence level of 95% (i.e.  $\pm$  twice the standard deviation). The typical measuring accuracy relates to average conditions for measuring within the specified range.

Measurement accuracy is not valid for

- basic functions (except stake outs),
- calculation,
- continuous measurement (tracking).

The maximum measuring error relates to unfavourable conditions such as:

- highly-reflecting surfaces (e.g. reflector tapes),
- operating at the limits of the permitted temperature range, adaption to ambient temperature interrupted (page 54)
- very bright ambient conditions, strong heat shimmer and can be up to  $\pm 5$  mm (twice the standard deviation).

\*\* At long range  $\pm 30$  ppm ( $\pm 3$  mm/100 m) plus short range error. Range increases, the better the laserlight is reflected from the target area (diffuse, not reflective), and the brighter the laserpoint is compared to the surrounding luminosity (indoors, dawn). From approx. 40 - 50 m use target plate, brown side.

**Possible method of calculating the standard deviation s:**

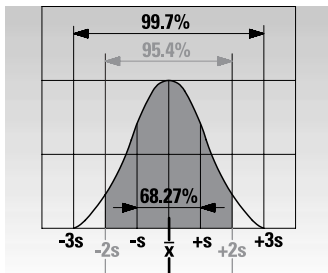

When using a computer with a statistical function or if you use the program Excel, you can calculate the mean value  $\bar{x}$  and the standard deviation  $s$  directly from the 10 measured values.

**Formula for the standard deviation s:**

$$s = \sqrt{\frac{1}{n-1} \sum_{i=1}^n (x_i - \bar{x})^2}$$

- $n$  ... number of measurements  
 $x_i$  ... individual value of a series of measurements  
 $\bar{x}$  ... mean value of a series of measurements

Calculation using the program Excel: On the Insert menu, choose Functions  
Select category: Statistics and Function: STABW within the Function Assistant.

 Depending on the version of Excel and the language used, the names of the menu may vary.

## Accuracy Tests

Accuracy tests on the DISTO for users certified to ISO 900...

You can perform your own accuracy tests on the DISTO to meet the requirements of ISO 900... for measuring equipment.

Take a fixed, invariable, and conveniently accessible distance of about 1m to 10m, such as the width of a window opening or of a room. Measure it ten times.

Determine the magnitude of this distance with a means of measurement that is monitored by a national, accredited calibration institute (traceability back to national standards).

Determine the amount that the measurements vary from the nominal distance, and compute the standard deviation.

Record the standard deviation and set a date for the next test.

## Message Codes

Repeat these tests at frequent and regular intervals, also before and after important measuring jobs.

Affix an adhesive label on the DISTO for accuracy tests of measuring equipment and keep a detailed record of the test procedure.

Your DISTO meets the specified accuracy if standard deviation remains smaller or equal to the typical specified value.

A DISTO whose measuring accuracy has been tested over a test distance works within the specified tolerance over the entire distance and temperature range specified in the manual.

Please note the technical data and the description of measuring accuracy in the manual

Error no.	Cause	Remedy
E702 - E706	Calculation error	Repeat entry
E252	Temperature above 50°C	Cool down instrument
E253	Temperature below 0°C	Warm up instrument
E255	Receiver signal too weak, Measurement time too long, distance < 250 mm	Use target plate Measurement time > 10 sec.
E256	Receiver signal too powerful	Use target plate (correct side)
E257	Wrong measurement, ambient brightness too high	Use target plate
E504	Not in data memory	No data available
E505	Data memory full	Erase memory location
E...	All other messages	Call service "system"



Press briefly to acknowledge message and to return to basic settings.



When messages with this symbol, appear even after DISTO has been used several times, then please call the service station and inform them of the message number displayed.

en

**1 measure settings**

- 1.1 reference
  - 1.1.1 front
  - 1.1.2 stand
  - 1.1.3 rear
- 1.2 offset
  - 1.2.1 addition
  - 1.2.2 subtraction
  - 1.2.3 none
- 1.3 timer
  - 1.3.1 once
  - 1.3.2 permanent
  - 1.3.3 none
- 1.4 laser
  - 1.4.1 normal mode
  - 1.4.2 permanent
- 1.5 tracking
  - 1.5.1 on
  - 1.5.2 off
- 1.6 send
  - 1.6.1 on
  - 1.6.2 only results
  - 1.6.3 off

**2 end cover**

- 2.1 without end cover
- 2.2 adapter end cover
  - 2.2.1 without add-on
  - 2.2.2 accessory 723775
  - 2.2.3 accessory 723776
  - 2.2.4 pivot gap
  - 2.2.5 individual extension

- 2.3 recognition
  - 2.3.1 on
  - 2.3.2 off
- (2.4 rotating foot)
- (2.5 aligning end)

**3 basic settings**

- 3.1 units
  - 3.1.1 0.000 m
  - 3.1.2 0.00 m
  - 3.1.3 0.00 feet
  - 3.1.4 0°00"/32
  - 3.1.5 0.0 in
  - 3.1.6 0"/32
- 3.2 language
  - 3.2.1 German
  - 3.2.2 English
  - 3.2.3 French
- 3.3 beep
  - 3.3.1 measure
  - 3.3.2 key
  - 3.3.3 off
- 3.4 reset
- 3.5 lighting
  - 3.5.1 on
  - 3.5.2 off
- 3.6 switch off

**4 basic functions**

- 4.1 maximumtrac
- 4.2 minimumtrac
- 4.3 required distance
  - 4.3.1 constant
  - 4.3.2 variable

- 4.4 pythagoras
- 4.5 height
- 4.6 accuracy
- 4.7 average

**5 calculation**

- 5.1 triangle SSS
- 5.2 triangle SH
- 5.3 trapeze HSH
- 5.4 trapeze HSD
- 5.5 gable area
- 5.6 circle
- 5.7 space

**6 memory**

- 6.1 memory key 1-9
- 6.2 recall key 1-9
- 6.3 stack
- 6.4 data
  - 6.4.1 text
  - 6.4.2 store
  - 6.4.3 change
  - 6.4.4 erase
  - 6.4.5 send
    - 6.4.5.1 all
    - 6.4.5.2 position

**7 calculator**

- 7.1 division
- 7.2 x2
- 7.3 square root

*Leica Geosystems AG, Heerbrugg, Switzerland has been certified as being equipped with a quality system which meets the International Standards of Quality Management and Quality Systems (ISO standard 9001) and Environmental Management Systems (ISO standard 14001).*



**Total Quality Management -  
Our commitment to total customer  
satisfaction**

Ask your local Leica Geosystems agent for more information about our TQM program.